

**ATARI<sup>®</sup> SM125<sup>™</sup>**

**High-Resolution  
Monochrome Monitor**

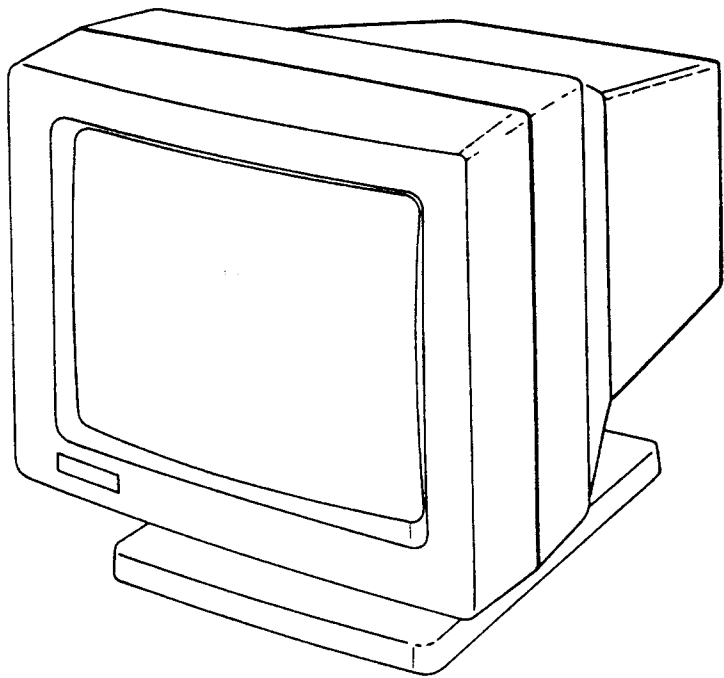

**For Use with All ATARI ST<sup>™</sup> Personal  
Computers**

**SERVICE** For Service Manuals  
contact  
**MAURITRON SERVICES**  
8 Cherry Tree Road, Chinnor  
Oxfordshire, OX9 4QY  
Tel (01844) 351694  
Fax (01844) 352554

Printed in Taiwan

P/N C026408

Réf. 80018

## CONTENTS

INTRODUCTION .....	2
OPERATION THEORY .....	4
SERVICE NOTES .....	7
TROUBLE SHOOTING GUIDE .....	11
WAVEFORMS AND VOLTAGES .....	14
PARTS LISTING .....	21
SCHEMATIC DIAGRAM .....	
EXPLODED VIEW .....	

Copyright c 1986, Atari Corp.  
All Rights Reserved

Every reasonable effort has been made to ensure the accuracy of this manual; however, due to ongoing changes, Atari Corporation cannot guarantee the accuracy of this information after the date of publication and disclaims liability for changes, errors, or omissions.

These documents are for repair service information only. Part numbers are for reference only. Only parts on current dealer parts list are available. No license is given for any use by the possession of these documents and may not be reproduced in any form without the written approval of Atari Corp.

## I. INTRODUCTION

The following general characteristics, electrical specifications and safety precautions are provided for your information and use in maintaining the performance of the monitor.

### 1. Twelve inch monochrome display characteristics.

AC Input	:	230V AC, 50Hz 22 Watts Maximum or 115V AC, 60Hz (jumper wire selectable)
Frequency Response	:	Video bandwidth: 30MHz -3dB at 30Vp-p signal at CRT cathode Rise and fall time: 10nsec.
Cathode Ray Tube	:	12 inches $\pm$ 0.5 inches diagonal 90°C deflection Neck size: 20mm Phosphor: P193 CIE color coordinate X = $0.307 \pm 0.02$ Y = $0.350 \pm 0.02$ Screen effect: chemical etching
Scanning Frequency	:	Vertical 71.41Hz Horizontal 35.714KHz
Input Impedance/ Polarity	:	Vertical 2K ohm / negative Horizontal 2K ohm / negative
Resolution	:	640 x 400 dots
Geometric Distortion/ Linearity	:	Within 10%
Ambient Temperature	:	0°C to 55°C (operating) 0°C to 65°C (storage)
Humidity	:	20% to 90% RH
Controls	:	A. Internal: Sub-Brightness V-Linearity Focus H-Width B+ 12V adjustment H-Phase V-Hold V-Size  B. External: Brightness Volume On/Off SW
Dimensions	:	Approx 323 x 323 x 325 mm (W x D x H)

Weight : Approx 7.5Kg

## 2. Adjustments

### 2.1 Brightness adjustment

Procedure:

- Step 1. Connect input signal cable.
- Step 2. Rotate external brightness control VR303 to maximum.
- Step 3. Rotate internal sub-brightness control VR302 to the threshold of the raster.
- Step 4. Adjust the external brightness VR for the desired brightness level.

### 2.2 Vertical size/Linearity adjustment

Procedure:

- Step 1. Connect a test pattern generator whose output is identical to the signal normally used.
- Step 2. Rotate the vertical size control VR202, until optimum size display is obtained.
- Step 3. Rotate the vertical linearity control VR203, until extreme top and bottom characters are equal in height to the center characters.
- Step 4. Readjust VR202 until the desired height is obtained.

### 2.3 Focus adjustment

Procedure:

The optimum focus of the monitor is obtained by adjusting the focus control VR304, for best focus at a point that is near the center and approximately 1/3 down from the top of the monitor.

### 2.4 Raster centering adjustment

Procedure:

- Step 1. Adjust vertical size control, VR202, so that all edges of the raster are visible.
- Step 2. Reposition the YOKE into the CRT for best raster centering.
- Step 3. Readjust the vertical size control, VR202, to specified dimensions.
- Step 4. Secure and bond the YOKE to the neck of the CRT using hot melt adhesive to prevent slipping off.

## 3. Safety precautions

**NOTICE:** Observe all cautions and safety related notes located inside the receiver cabinet and on the receiver chassis.

## WARNING

To prevent fire or shock hazard  
Do not expose this appliance to  
rain or moisture.

### X-Radiation Warning

To avoid possible exposure to X-Radiation take X-Radiation protective measures for personnel.

### During Servicing

See service instructions for specified replacement parts and service adjustments.

## II. OPERATION THEORY

### A. SWITCHING MODE POWER SUPPLY

#### 1.0 Scope

The chapter provides service information for a 22 Watts single output (12V), single phase input (120 or 240 VAC) switching-mode power supply (S.M.P.S.).

#### 2.0 General Specifications

- |                                |   |   |
|--------------------------------|---|---|
| 2.1 AC operation voltage I/P   | : | 120VAC (90 – 130VAC) or 240VAC (180 – 260VAC) |
| 2.2 AC operation frequency I/P | : | 47 – 63 Hz                                    |
| 2.3 DC O/P regulation          | : | 12 ± 1% VDC for Vo1; ± 5% for Vo2             |
| 2.4 DC O/P current             | : | 1.2 – 1.5A for Vo1; 300 mA for Vo2            |

#### 3.0 Theory of operation

Reference to Figur. 1, S.M.P.S. block diagram and Figure circuit diagram.

##### 3.1 Block diagram description

The AC Line is connected to rectifier (D701 – D704) through the line filter (L701, C701 – C704), when the power switch (SW700) is turned on. The rectifier and DC filter circuit produce about 300 VDC from the AC Line. After the input capacitors (C710, C712) are charged, the start circuit (R705, C716 etc) make the switching circuit (Q701) and the power transformer (T701) operate. The power transformer converts the 300 VDC to 35.714KHz (Horizontal Frequency) oscillation square wave and transfers the high voltage to appropriate level for the output voltage which is produced by half wave rectification and LC filter (D712, C722, C723, L702 etc). The outputs are 12 VDC which are sensed and regulated by the power transformer that control duty cycle modulator (ZD702, Q702 – Q704 etc) and drive circuit (C716, R706 etc).

#### 4.0 Circuit description

The following paragraphs describe each block of the Block Diagram

##### 4.1 Rectifier and DC filter (120 VAC operation)

When the power supply is connected for 120 VAC line operation the jumper wire J701 should be short. That the rectifier (D701 – D704) is connected as doubler producing 300 VDC.

##### 4.2 Rectifier and DC filter (240 VAC operation)

When the power supply is connected for 240 VAC, the jumper wire J701 should be open. That the rectifier circuit is used as a bridge rather than a doubler as in the 120 VAC connection. In this case, the rectifier output is also approximate 300 VDC.

##### 4.3 Start circuit, Switching circuit, Power transformer

When the rectifier output is reaching 300 VDC, the start circuit make the switching circuit operation, then the power transformer converts 300 VDC to 35.714 KHz square wave and transfers it to the appropriate level for the output.

##### 4.4 Duty cycle modulator & drive circuit

Duty cycle modulator provide a reference voltage DC 6.2V (ZD709) to compare with output voltage sensor (12V output voltage adjustment VR701) that control the feedback voltage of the transformer, so duty cycle modulation and switching operation will be completed.

##### 4.5 Isolation transformer (T702)

It makes the oscillation frequency of the switching circuit synchronize with the horizontal frequency.

#### B. VIDEO CIRCUIT

The video signal is applied to the input connector cable. The IC 401 SN7406 is utilized as video buffer/former circuit. The video amplifier gain is decided by R407, and load resistor R415. The peaking coil L401 is compensated for video frequency response. D403 is a protection diode.

#### C. CRT CIRCUIT

High voltage is applied to the CRT bulb to provide anode voltage. "CAUTION". This is very high voltage, over several thousand volts. D311 rectified the pulse from flyback then filtered by C406 to maintain at a normal 40 Volts is used for Q402 collector. Grid G2 is the acceleration grid and is maintained at a normal 600 Volts rectified by D309 and C318, G4 is the focus grid. VR304 adjust the focus voltage from -100V to 600V to improve focus.

#### D. VERTICAL CIRCUIT

3.1 The vertical IC TDA1170N is a monolithic integrated circuit in a 12 – lead quad

in-line plastic package. The functions incorporated are:

- 1) Synchronization circuit
- 2) Oscillator and ramp generator
- 3) High power gain amplifier
- 4) Flyback generator
- 5) Voltage regulator

### 3.2 Oscillator circuit

The vertical sync pulses are coupled through C201 to pin 8 of IC201, VR201 adjusts the frequency of the vertical oscillator. The D202, C210 is made up of pump up voltage.

### 3.3 Vertical output

The vertical sweep output is obtained at pin 4, 10 and 11 of IC201. R212, C205, R211 are made up of DC feedback of amplifier. R209, R210 are AC feedback.

The vertical size of the raster or amplitude of the sweep is adjusted by VR202. The linearity of the vertical sweep is adjusted by VR203.

## E. HORIZONTAL CIRCUIT

The IC301 SN74LS221 is a dual, monolithic, non-retriggerable, high-stability one shot. The output pulse width,  $t_w$  can be varied over 9 decades of timing by proper selection of the external timing components, C303 and R304, C304 and R303. Pulse width is defined by the relationship:

$$t_w (\text{out}) = C_{\text{ext}} R_{\text{ext}} \ln 2 = 0.7 C_{\text{ext}} R_{\text{ext}}$$

The flyback transformer generates the high voltage necessary for the anode voltage of the CRT. A secondary winding supplied G1; G2. The deflection coil current source is also obtained from the output of Q302. The amplitude of the pulse is approximately 190Vp-p, L302 adjust horizontal width, and L303 controls the horizontal linearity. C307 is a S-shaping capacitor.

## F. HIGH VOLTAGE SUPPLY CIRCUIT

High voltage is obtained by rectification of the high voltage output of the flyback transformer T301. This diode is molded into the transformer housing.

## G. AUDIO CIRCUIT

The IC501 is an audio amplifier. The power supply is provided from pin 6. Pin 4 is the ground lead. The input audio signal is coupled from pin 3 and after amplified the output signal is from pin 5 to the speaker. VR501 is volume adjustment. C505 is a compensation capacitor to avoid from high frequency oscillation. R504, C504 can increase the high frequency loading and keep from the high-frequency oscillation. R502 is a voltage gain resistor. C502 is a DC block capacitor. R503, C507 are the impedance matching components R501 is

the bias resistor. C501, C510 and C506 are the signal coupling capacitor. C508 is the filter capacitor.

### III. SERVICE NOTES

The service notes given here are to be utilized in maintaining monitor. The theory of operation in chapter II can be used for normal operation. The flow charts in this chapter should help isolate any given failed component.

#### 1. Circuit tracing

Component reference numbers are printed on top and bottom of the circuit board to facilitate circuit tracing. In addition, control names and board terminal numbers are also shown and are referenced on the chassis schematic diagram in this manual.

#### 2. Component removal

Removal components from the etched board is facilitated by the fact that the circuitry appears on one side of the board only and the component leads are inserted straight through the holes and are not bent or crimped. The nozzle of the soldering gun is inserted directly over the component lead and when sufficiently heated, the solder is drawn away leaving the lead free from the copper plating.

#### 3. General troubleshooting

The brightness control should be adjusted to maximum, when power up, the examination of the unit should follow the flow chart shown in Fig. 2. Does the unit have a high frequency sound? If it does, this means that high voltage is being generated. If not, then go to the horizontal diagnostic flow chart. If there is high voltage and a visible raster, then the problem may be diagnosed using the regular diagnostic flow chart. If there is high voltage but no visible raster, there is probably a video problem. Follow the video diagnostic flow chart. If the unit is completely dead, one and both fuses probably blown.

#### 4. Troubleshooting video circuit

Fig. 3 contains a step-by-step troubleshooting guide for isolating the malfunctioning components in your monochrome display. Is there a video source connected to the unit? If not, check for broken connections or a loose connector. If the waveform of the emitter of Q402 exists, see if the waveform of the collector of Q402 exists? If not, then Q402 or video B+ is defective. If waveform of the emitter of Q402 not exist, IC401 or Q401 may be bad or there may be a bad passive component in this area. If Q402 collector waveform exist, the CRT is probably bad. Use safety precautions to handle the CRT and remember to discharge the aquadag voltage built up on the CRT.

#### 5. Troubleshooting vertical circuit

The vertical circuit in general are all contained in IC201. If the unit has only a horizontal line or a very distorted vertical image, check the deflection YOKE for a short or IC201 may be defective or a passive components is bad. Due to the complete vertical circuit being contained in one integrated circuit, very few problems have been encountered in this area.



## 6. Troubleshooting horizontal circuit

The horizontal circuits are diagnosed using the flow chart shown in Fig. 4. The methodology used, is to start at the back and work forward. Is waveform of collector pulse Q302 present? If waveform is present but there is no high voltage being generated, the problem is usually a broken printed board land around the horizontal flyback transformer. If waveform is not present, is waveform of BASE Q302 present? If so, then Q302 or the horizontal flyback is probably bad. If waveform is not present, then IC301 is probably defective.

## 7. Troubleshooting high voltage circuit

If the horizontal processing and sweep generator are functioning, the unit is probably generating both the bootstrap and aquadag voltages. If not, then check for broken printed circuit board lands or defective diodes. The rectifier diode for the quadag voltage is not accessible. The horizontal flyback transformer must be replaced.

## 8. Mechanical adjustments

### 8.1 CRT replacement

- A. Remove the anode cap from CRT small cavity cap.
- B. Remove the CRT SOCKET from CRT pin BASE.
- C. Loosen the screw of the deflection Yoke, remove the deflection YOKE from CRT CONE.
- D. Remove the four screws.
- E. Take off the CRT ground connector.
- F. Remove the CRT from cabinet.

### 8.2 Raster centering

The centering device consists of two levers attached to the rear of the deflection YOKE. By turning these two levers alternately, you can adjust the picture so that it will come to the center of the screen.

### 8.3 Deflection YOKE

When the scanning lines of the raster are not horizontal or corner shades appear, loosen the screw securing the deflection YOKE and press the deflection YOKE hard against the root of the neck of the picture tube, adjust by turning to the right or left so that the scanning line of the raster will be horizontal.

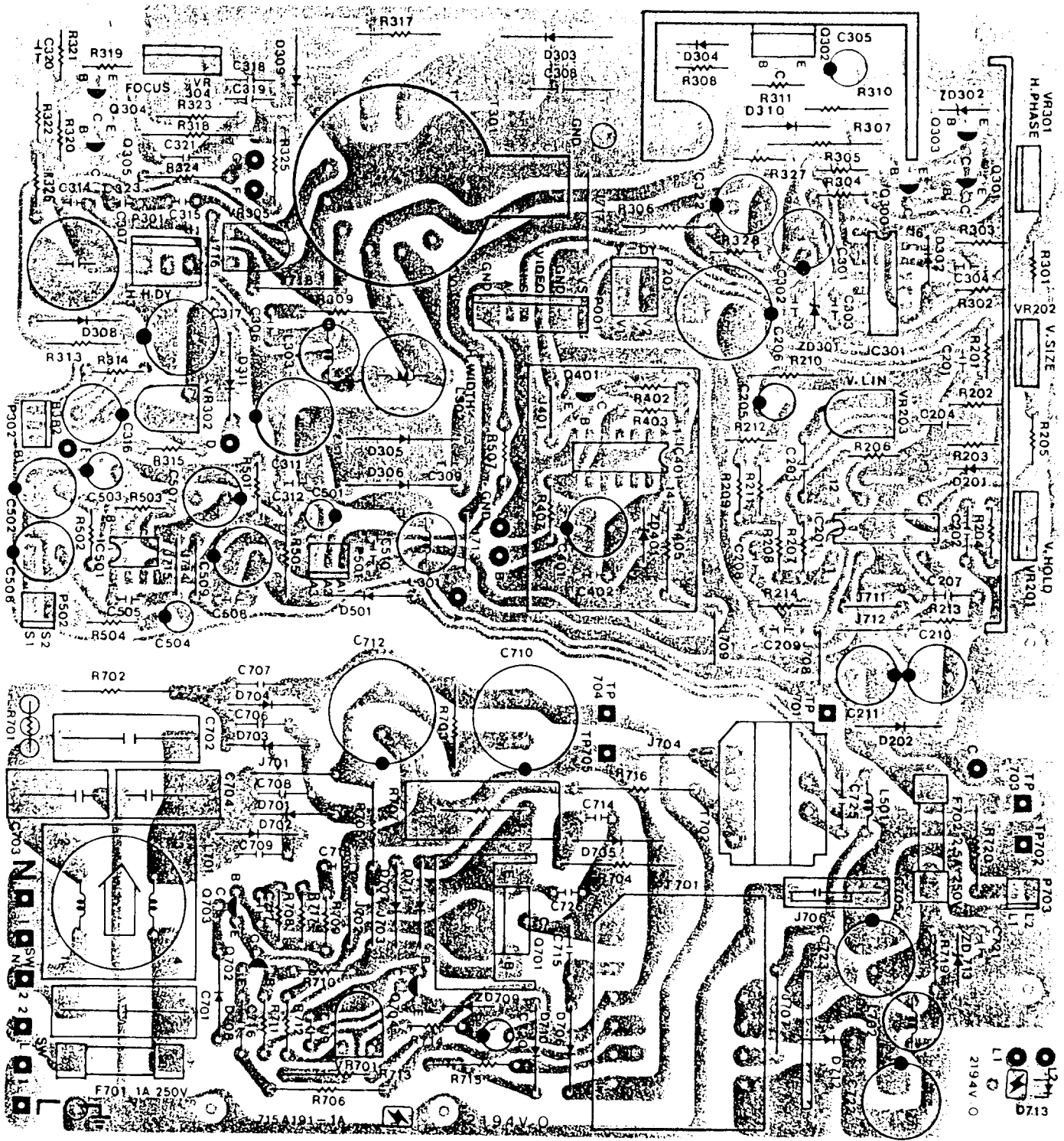

10) BLOCK DIAGRAM WITH SM125

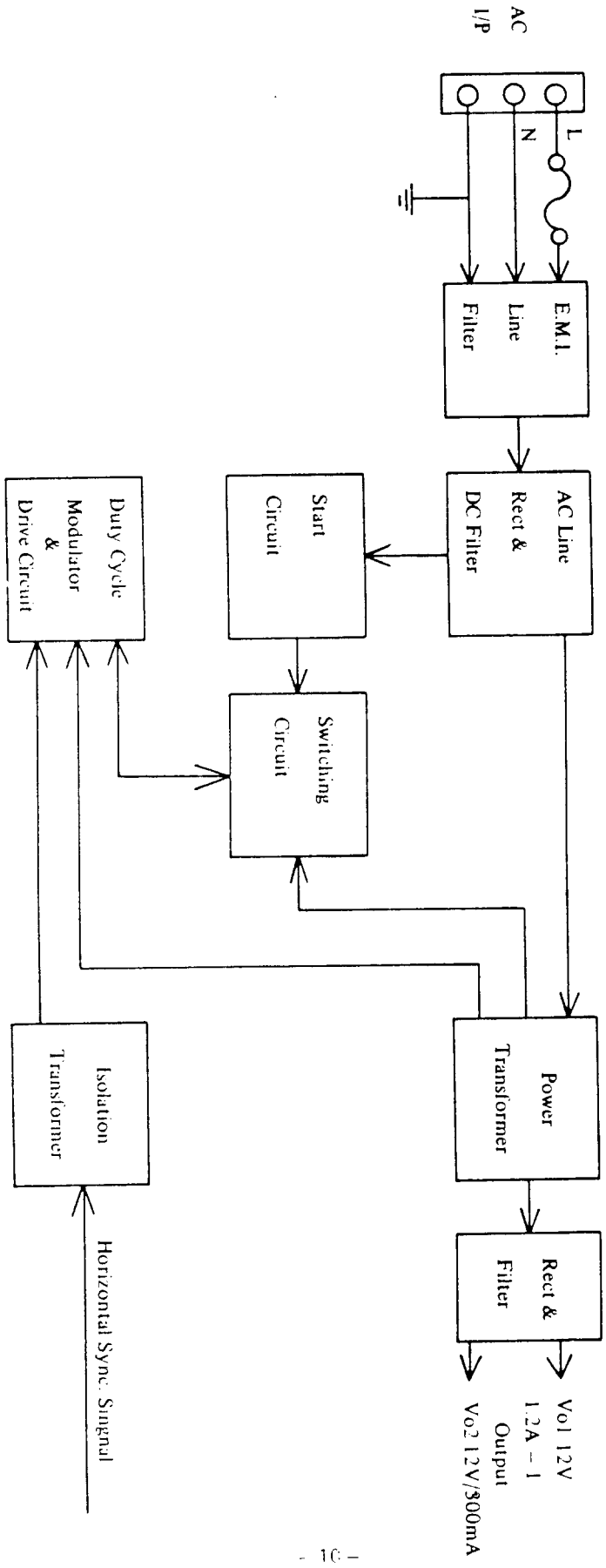

Figure 1

S.M.P.S. BLOCK DIAGRAM

11) TROUBLE SHOOT

For Service Manuals  
 contact  
**MAURITRON SERVICES**  
 8 Cherry Tree Road, Chinnor  
 Oxfordshire, OX9 4QY.  
 Tel (01844) 351694  
 Fax (01844) 352554

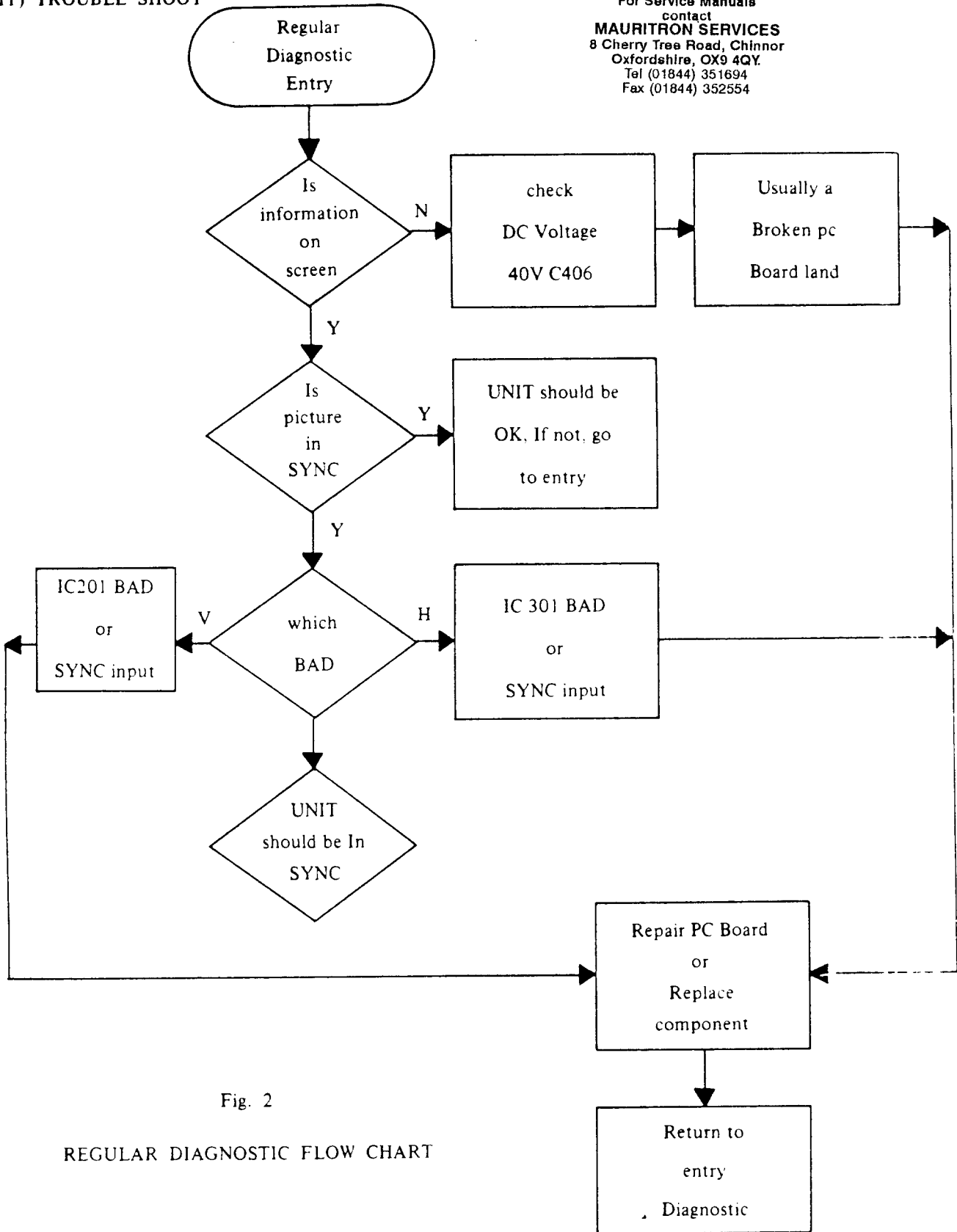

Fig. 2

REGULAR DIAGNOSTIC FLOW CHART

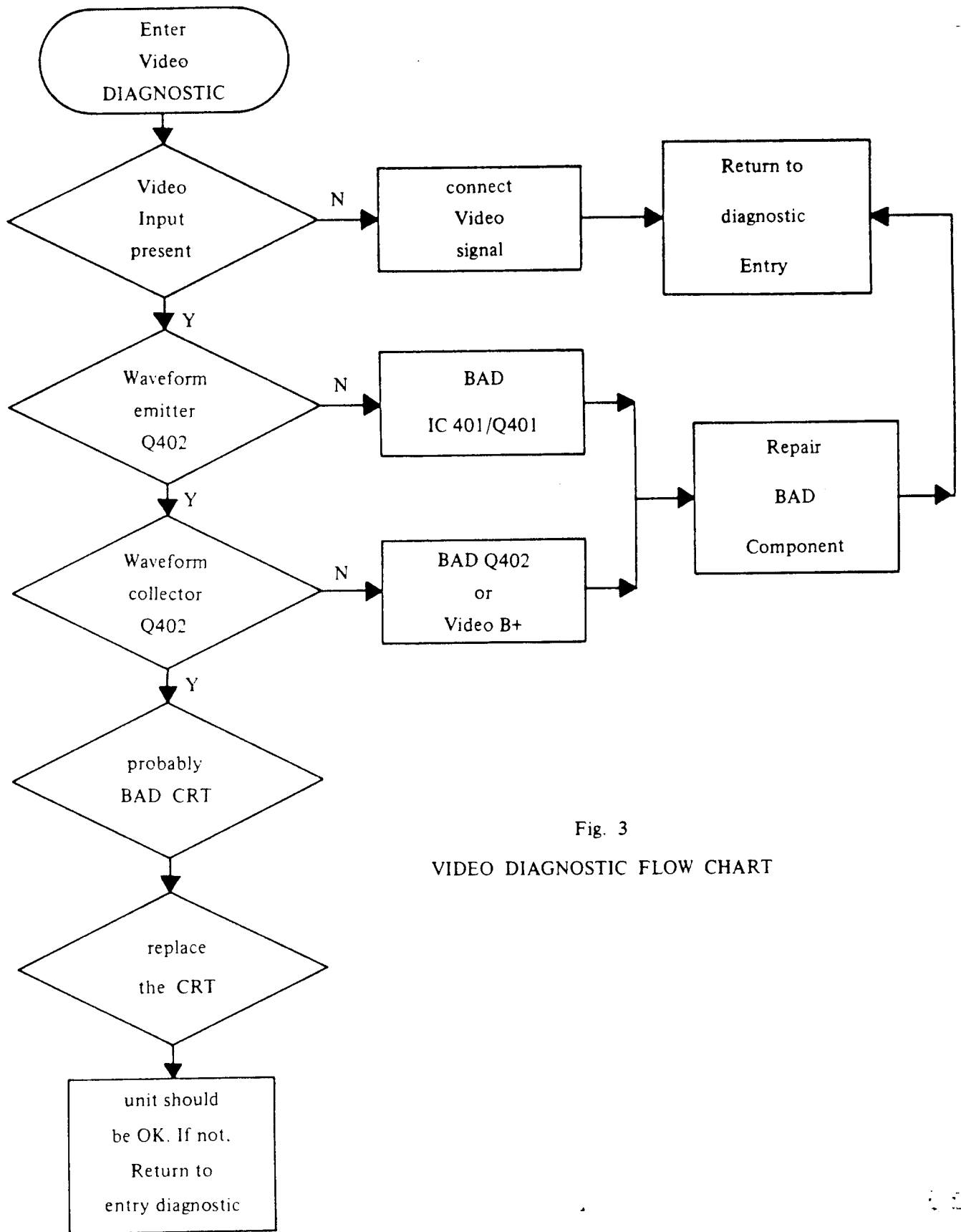

Fig. 3  
VIDEO DIAGNOSTIC FLOW CHART

For Service Manuals  
 contact  
**MAURITRON SERVICES**  
 8 Cherry Tree Road, Chinnor  
 Oxfordshire, OX9 4QY.  
 Tel (01844) 351694  
 Fax (01844) 352554

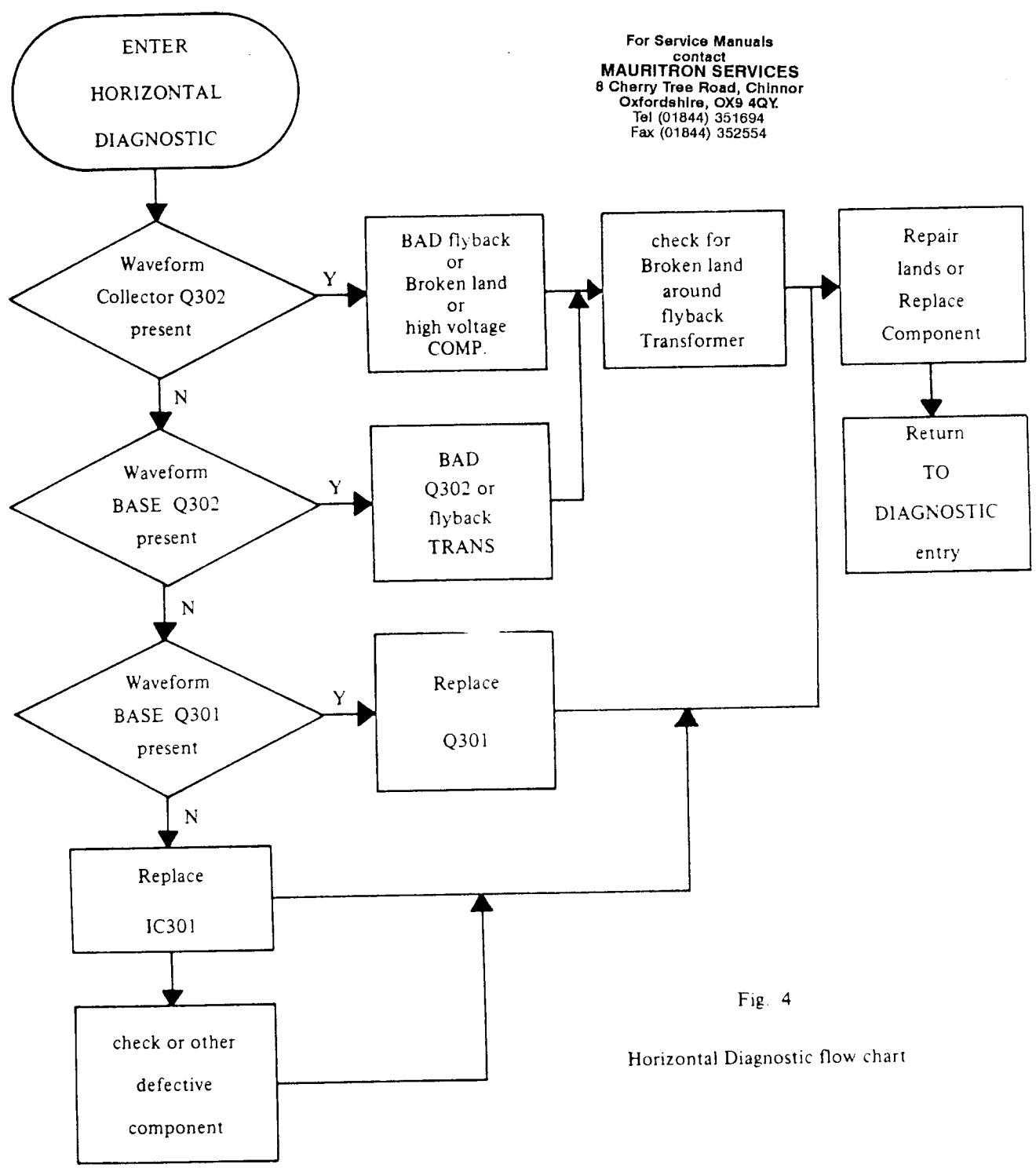
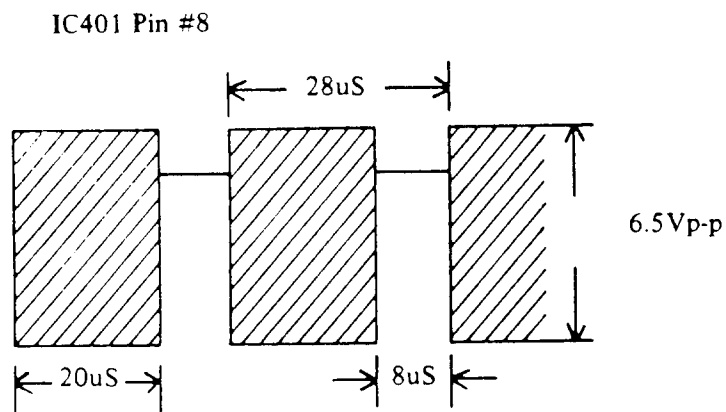
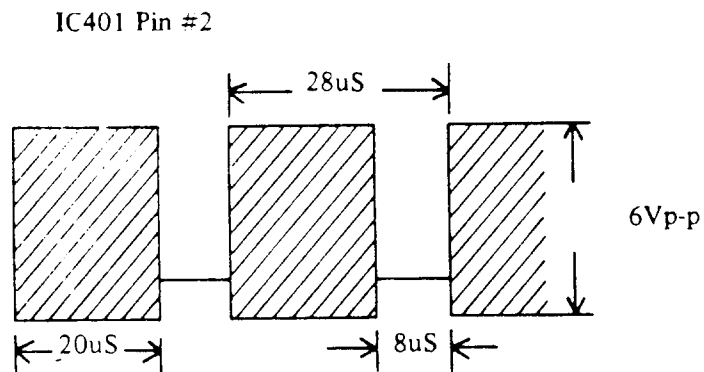
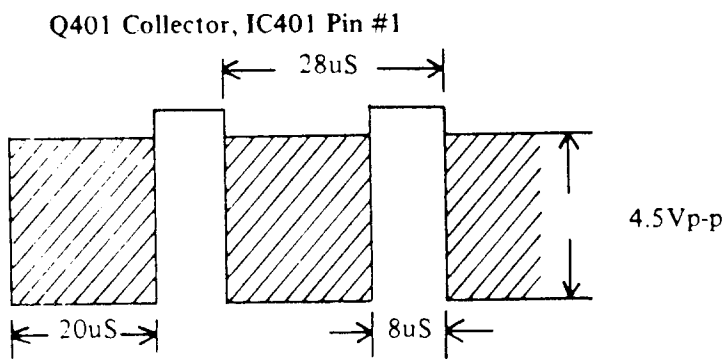
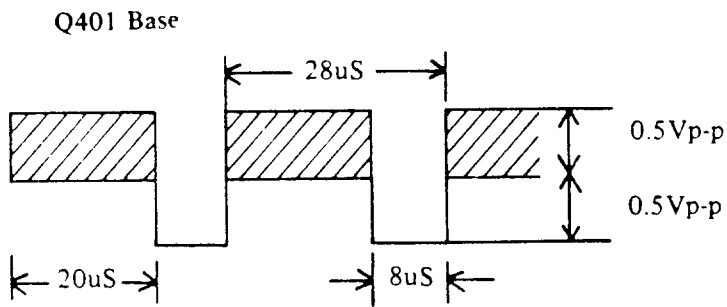

Fig. 4

Horizontal Diagnostic flow chart

#### IV. WAVEFORMS AND VOLTAGES



Q401	DC Voltage
Base	0.45V
Collector	2.65V
Pin # 1 <u>IC401</u>	2.65V
Pin # 2	2.32V
Pin # 3	NC
Pin # 4	NC
Pin # 5	2.32V
Pin # 6	2.13V
Pin # 7	0
Pin # 8	2.13V
Pin # 9	2.32V
Pin #10	2.13V
Pin #11	2.32V
Pin #12	NC
Pin #13	NC
Pin #14	5.17V

Q402 Emitter

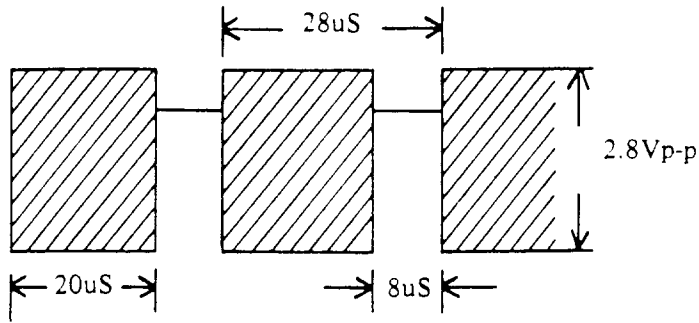

Q402	DC Voltage
Base	4.35V
Collector	22.7 V
Emitter	3.86V

Q402 Collector

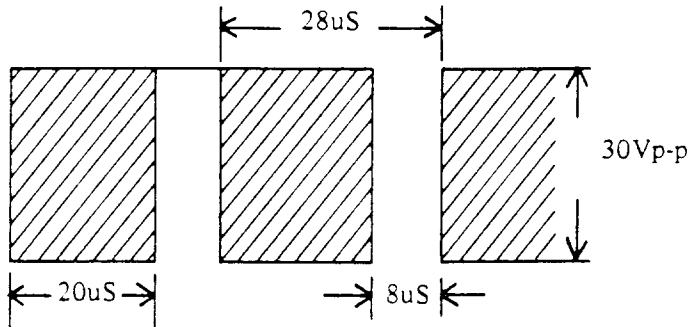

Vertical IC201 56A157-1  
PIN #1

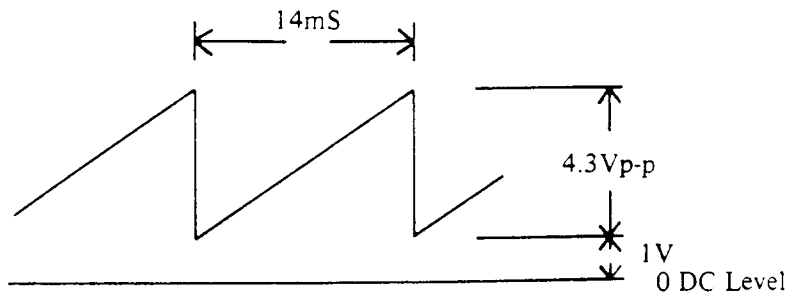

IC201	DC Voltage
Pin #1	3.1 V
Pin #2	12 V
Pin #3	6.23V

Pin #3

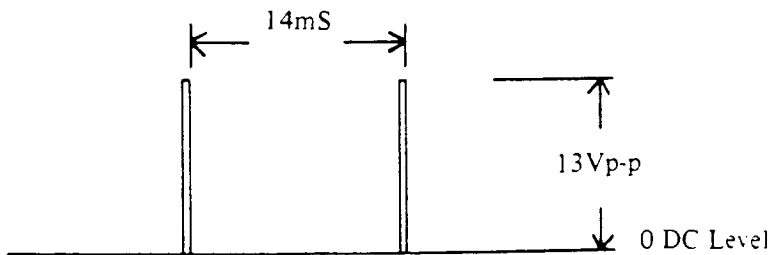



Pin #4

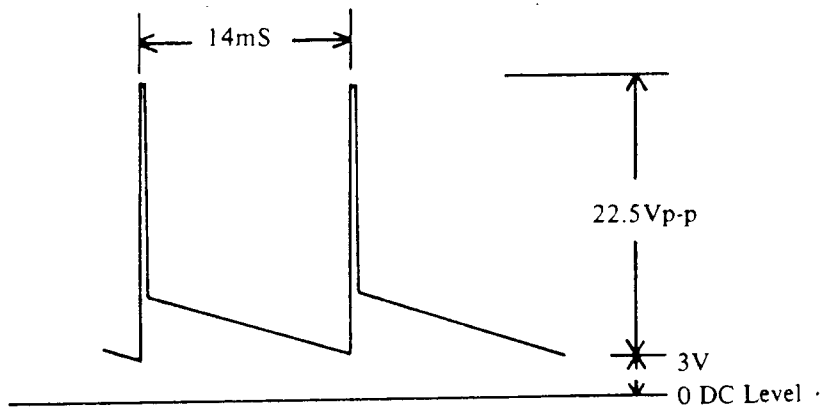

Pin #5

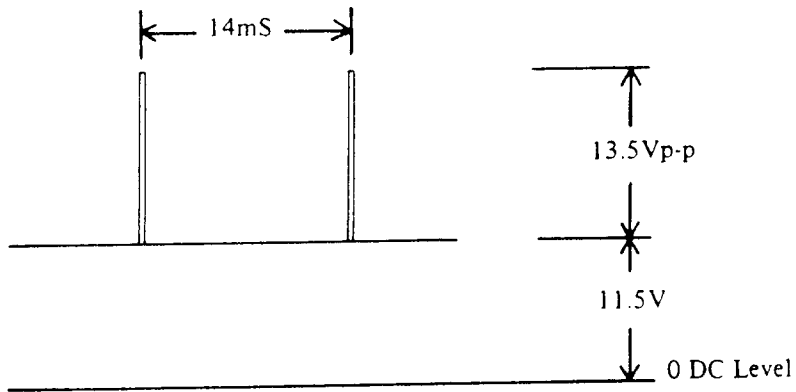

Pin #8

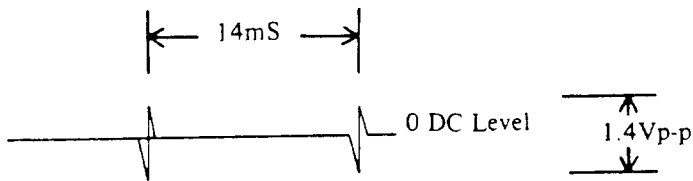

Pin #9

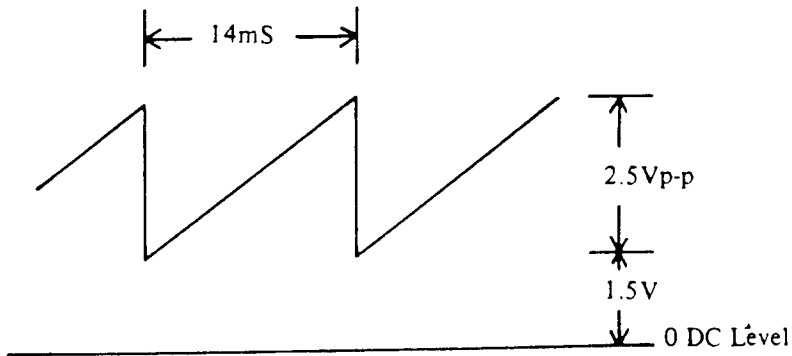

IC201	DC Voltage
Pin # 4	6.3 V
Pin # 5	11.6 V
Pin # 6	6.59V
Pin # 7	6.69V
Pin # 8	0
Pin # 9	2.85V
Pin #10	2.1 V
Pin #11	0.69V
Pin #12	2.4 V

Pin #10

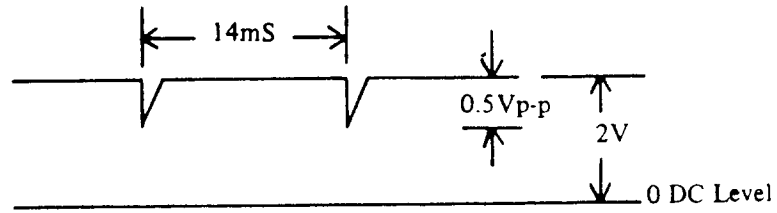

Pin #11

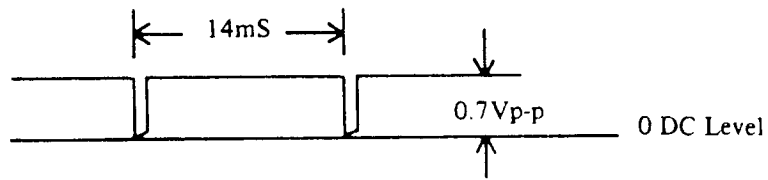

Pin #12

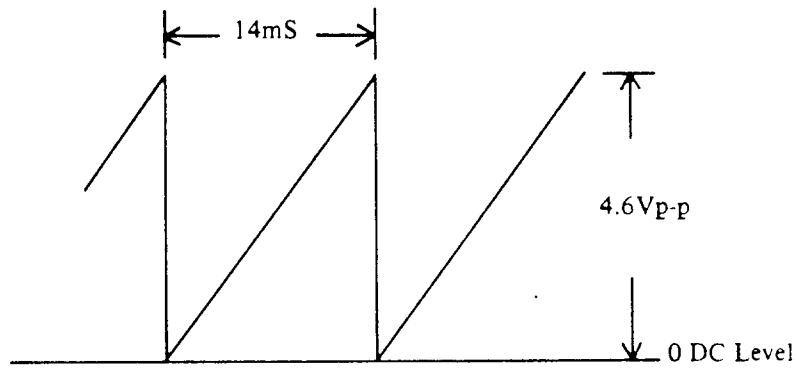

Horizontal IC301 56A74LS-221

Pin #1 , Pin #5

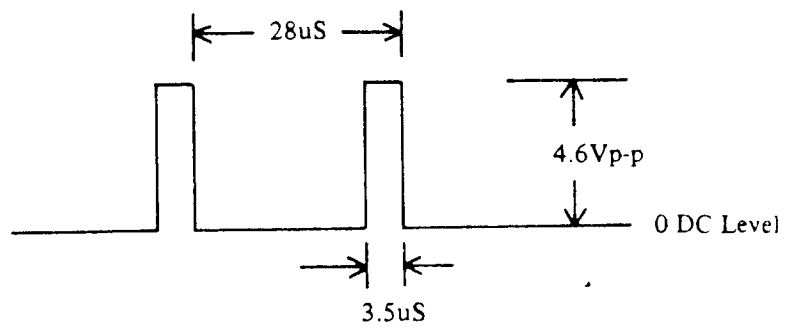

Pin #4

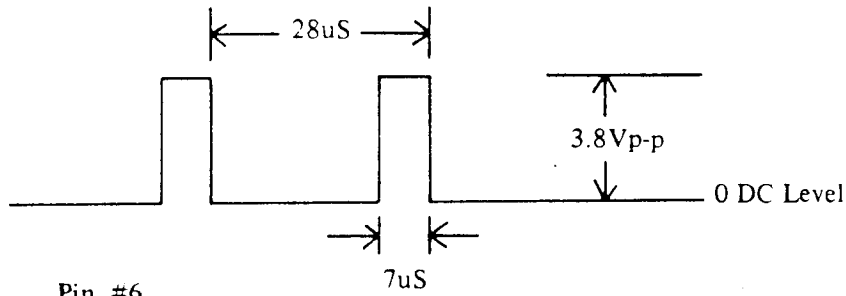

Pin #6

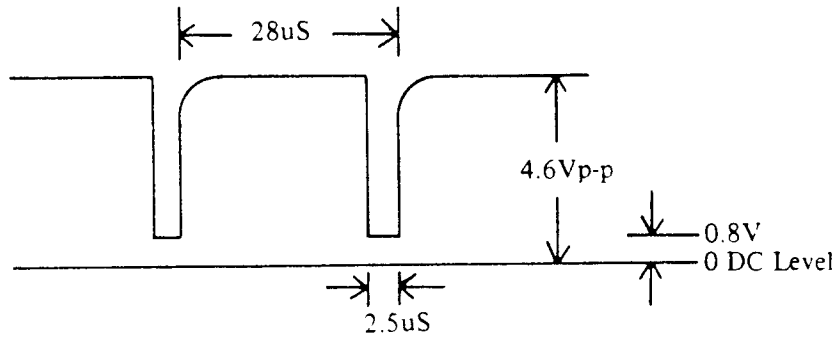

Pin #7

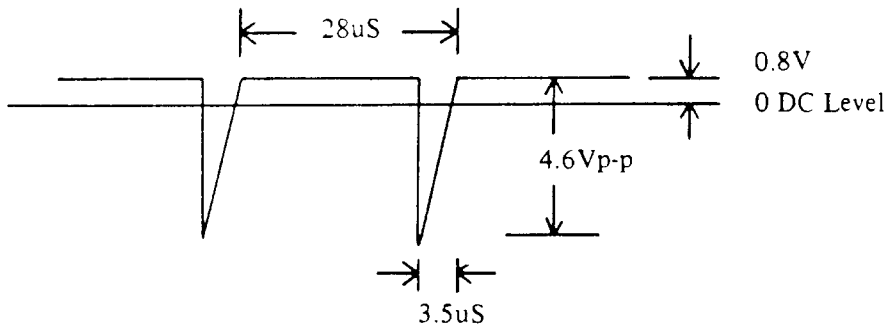

Pin #10

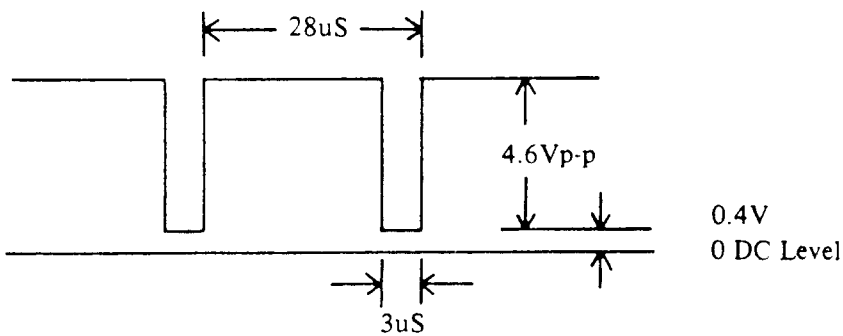

IC301	DC Voltage
Pin # 1	0.63V
Pin # 2	5.18V
Pin # 3	5.18V
Pin # 4	1 V
Pin # 5	0.63V
Pin # 6	4.5 V
Pin # 7	0.56V
Pin # 8	0
Pin # 9	0
Pin #10	4.41V
Pin #11	5.18V
Pin #12	NC
Pin #13	NC
Pin #14	1.7 V
Pin #15	5.18V
Pin #16	5.18V

Pin #14

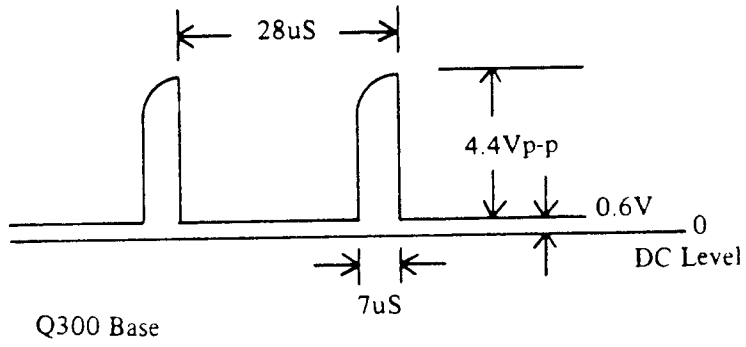

Q300	DC Voltage
Base	0.6 V
Collector	3.5 V
Q302	Voltage
Base	0.32V

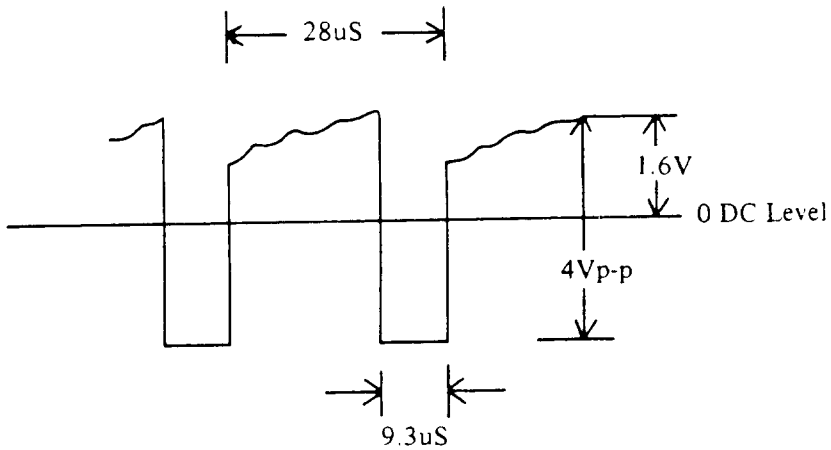
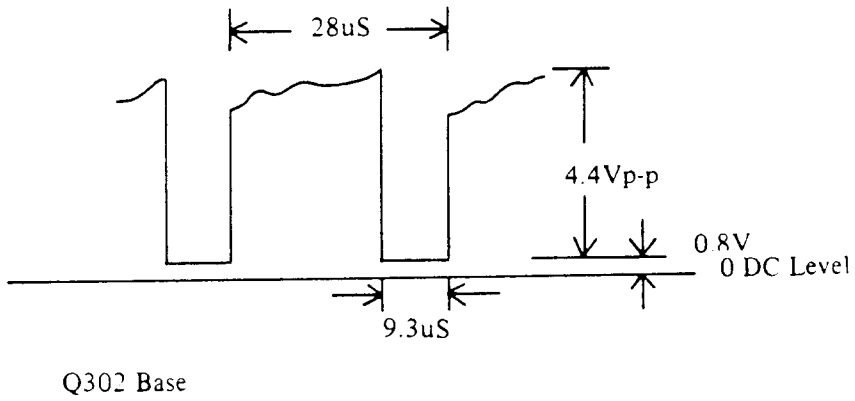
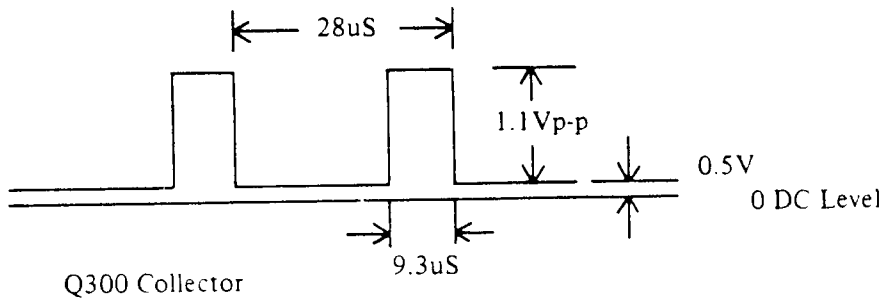

Q302 Collector

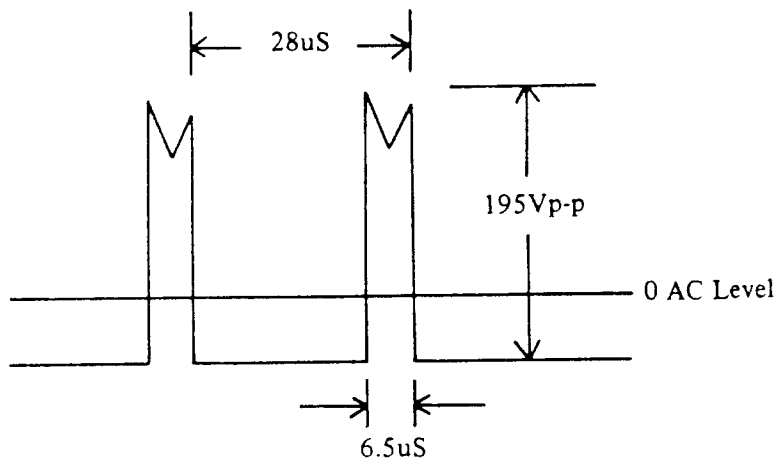

Horizontal Deflection YOKE Current

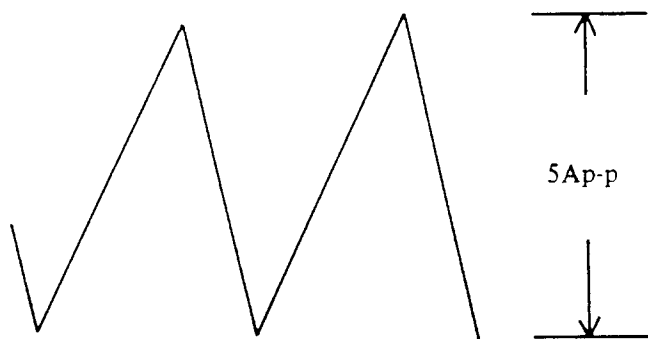

Vertical Deflection YOKE Current

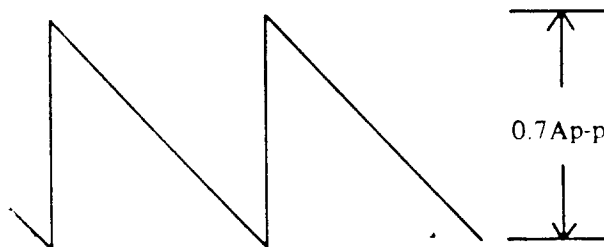

## PARTS LISTING

CIRCUIT NO.	PARTS NO.	DESCRIPTIONS
	M2CM-02-A	CHAS (12" -35.714KHZ)
	MBM2	CHAS (12" -35.714KHZ)
	1T421-9-128	MBM-/MCM- (COMMON)
	3C1-40-106	4x11 STEEL
	4C1-44-128	LOCK WASHER
	4C1-55-106	STELL
	4C1-97-128	.171x7/16x1/32 STEEL
	5A38-1	STEEL
	5B38-10	RUBBER
	5B38-11	RUBBER
	11D27-3	RUBBER
	11D27-12	NYLON
	12T308-2	NYLON
	15T5308-1	RUBBER
	23T3047-8	PCB FRAME
	26A156-24	ALUMINUM
	33T3262-3	SERIAL NO. LABEL
	33T3264-1	A.B.S. PLASTIC
	34E423-6	A.B.S. PLASTIC
	34E424-10	A.B.S. PLASTIC
	34E425-10	A.B.S. PLASTIC
	34E426-5	A.B.S. PLASTIC
	40A153-2	LABEL
	40A153-11	WARNING LABEL
	40A155-224	WARNING LABEL
	40A156-10	WARNING LABEL
	40A202-32	ID LABEL
	41A401-51	CSA LABEL
	44T3033-8	CARTON
	89A173-6	SIGNAL CORD
	89A500-1	POWER CORD
	97A221-11	CRT MONO 12V CE745W12K193VR
	K1S350-25-128	M5x25 STEEL
	K1S401-805-120	# 8x5/8
	K1S404-603-128	# 6x3/8
	M1S440-6-127	M4x6
	1T421-4-128	3x10
	2C9-77-128	STEEL

CIRCUIT NO.	PARTS NO.	DESCRIPTIONS
	3C1-111-46	.166x.610
	8B7-58	STEEL
	15T5266-1	TERNEPLATE
	19B199-6	PRE-TIN MUSIC WIRE
	44T3033-1	E.P.S.
	44T3033-2	E.P.S.
	45C77-1	TRANSPARENT SHEET
	45C86-1	PE
	50S102-5	PLASTIC
	50S103-2	PLASTIC TIE
	G1S140-18-120	4MMx18 STEEL
	K1S401-805-120	# 8x5/8
	K1S401-806-128	# 8x3/4
15T52	K1S401-805-120	# 8x5/8
34E42	15T5267-1	TERNEPLATE
34E42	15T5267-2	TERNEPLATE
34E42	K1S401-805-120	# 8x5/8
34E42	G1S140-18-120	4MMx18 STEEL
34E42	K1S401-805-120	# 8x5/8
	BMPC-02-A	PC BOARD -35.714KHZ
	9A94-1	BRASS
	9B96-2	BRASS
	9S206-5	CONNECTOR
	15T5226-2	TERNEPLATE
	33T3072-11	3P HOUSING PLASTIC
	33T3072-15	2P HOUSING
	33A3253-1	2 PIN HOUSING
	33A3253-2	3 PIN HOUSING
	78A297-1	SPEAKER
		1W 16 OHM 2.5" SQUAR
	89A201-2	CABLE SHIELD AUDIO
	94A376-1	DEFL YOKE
	95A101-9	3x #24
	95S101-22	2x24 WHT
	95S203-51	22 AWG STRAND BRN
	95S203-54	22 AWG STRAND YEL
	95S205-30	18 TOP/CT BLK
	95S205-51	22 TOP/CT BRN
	95S205-52	22 TOP/CT RED
	95S205-54	22 TOP/CT YEL
	95S205-55	22 TOP/CT GRN

CIRCUIT NO.	PARTS NO.	DESCRIPTIONS
	95S205-56	22 TOP/CT BLU
	95S207-57	#22 STRAND VIO
	95S400-1	YEL/GRN WIRE (VDE)
	96B29-6	SHRINK TUBE
D713	81A7-1	LED (2x5MM)
H	95S205-52	22 TOP/CT RED
SW700	77A306-3A	SWITCH
VR303	75D303-15	VARIABLE RESISTOR 100K ± 20% 16MM
VR501	75D303-15	VARIABLE RESISTOR 100K ± 20% 16MM
	3C1-1-46	WASH LCK EX-TTH 4
	5B42-1	NYLON
	9A92-13	BRASS
	32B898-11	MICA
	33T3346-1	FUSE COVER
	63S107-1	CAPACITOR .1UF M 250V AC
	84B33-4	FUSE CLIP
	87C164-6	SOCKET CRT
	90T136-3	HEAT SINK
	90T151-2	HEAT SINK
	90T156-2	ALUMINUM
	93D60-73	DIODE FRD 3A 100V IR 31DF1
	C1S830-9-120	3MMx9MM STEEL
	K1S330-7-128	M3x7 STEEL
	K1S330-10-128	M3x10
	K1S404-603-128	# 6x3/8
	715A189-1	PC BOARD (CRT DRIVE)
	715A191-1A	PC BOARD (MAIN BOARD)
C201	64A185-17-58	CAPACITOR POLYESTER 0.022UF J 50V
C202	64A177-25-57	CAPACITOR POLYESTER 0.1UF J 50V
C203	64A177-27-57	CAPACITOR POLYESTER 0.15UF J 50V
C204	64A177-27-57	CAPACITOR POLYESTER 0.15UF J 50V
C205	67A301-220-3	CAPACITOR ELECTROLYTIC 22UF +100-10% 16V



CIRCUIT NO.	PARTS NO.	DESCRIPTIONS
C206	67S201-222-2	CAPACITOR ELECTROLYTIC 2200UF +100-10% 10V
C207	64A177-25-57	CAPACITOR POLYESTER 0.1UF J 50V
C208	65S444-471-1	CAPACITOR CERAMIC 470PF K Z5P 50V
C209	65S442-330-1	CAPACITOR CERAMIC 33PF J NPO 50V
C210	67A301-101-3	CAPACITOR ELECTROLYTIC 100UF +100-10% 15V
C211	67S201-471-3	CAPACITOR ELECTROLYTIC 470UF +100-10% 15V
C301	67S201-221-3	CAPACITOR ELECTROLYTIC 220UF +100-10% 15V
C302	65A452-104-3	CAPACITOR CERAMIC .1UF +80-20% 16V Z5U
C303	64A103-23	CAPACITOR CERAMIC 560PF 50V ± 5%
C304	64A103-24	CAPACITOR POLYPROPYLENE 0.0012UF 5% 50V
C305	67S301-470-3	CAPACITOR ELECTROLYTIC 47UF +100-10% 16V
C306	65A1K-102-1A	CAPACITOR CERAMIC 1000PF K Z5F 1KV
C307	67A50-229-7	CAPACITOR ELECTROLYTIC 2.2UF 50V N.P.
C308	64A140-50-64	CAPACITOR POLYESTER 0.015UF J 400V
C309	65A1K-102-1A	CAPACITOR CERAMIC 1000PF K Z5F 1KV
C311	67S201-102-3M	CAPACITOR ELECTROLYTIC 1000UF +100-10% 15V
C312	65S444-103-1	CAPACITOR CERAMIC 10000PF K Z5P 50V
C316	67S201-100-10	CAPACITOR ELECTROLYTIC 10UF +100-10% 160V
C317	67S201-221-7	CAPACITOR ELECTROLYTIC 220UF +100-10% 50V
C318	65A1M-103-3B	CAPACITOR CERAMIC 10000PF M Z5U 1KV
C319	65A1M-103-3B	CAPACITOR CERAMIC

CIRCUIT NO.	PARTS NO.	DESCRIPTIONS
C320	65S444-681-1	10000PF M Z5U 1KV CAPACITOR CERAMIC
C321	65A1M-103-3B	680PF K Z5P 50V CAPACITOR CERAMIC
C322	67D90-15	10000PF M Z5U 1KV CAPACITOR ELECTROLYTIC
C323	64A185-17-58	1UF 350V CAPACITOR POLYESTER
C401	67S201-221-3	0.022UF J 50V CAPACITOR ELECTROLYTIC
C402	65A452-104-3	220UF +100-10% 15V CAPACITOR CERAMIC
C404	67A301-101-3	.1UF +80-20% 16V Z5U CAPACITOR ELECTROLYTIC
C405	65A1M-103-3B	100UF +100-10% 15V CAPACITOR CERAMIC
C406	67S201-101-7M	10000PF M Z5U 1KV CAPACITOR ELECTROLYTIC
C407	65A1M-103-3B	100UF +100-10% 50V CAPACITOR CERAMIC
C408	65A1M-103-3B	10000PF M Z5U 1KV CAPACITOR CERAMIC
C501	67A301-100-3	10000PF M Z5U 1KV CAPACITOR ELECTROLYTIC
C502	67A301-101-3	10UF +100-10% 15V CAPACITOR ELECTROLYTIC
C503	67S301-470-3	100UF +100-10% 15V CAPACITOR ELECTROLYTIC
C504	67A301-228-7	47UF +100-10% 15V CAPACITOR ELECTROLYTIC
C505	65S444-681-1	0.22UF +100-10% 50V CAPACITOR CERAMIC
C506	67S201-221-3	680PF K Z5P 50V CAPACITOR ELECTROLYTIC
C507	67A301-101-3	220UF +100-10% 15V CAPACITOR ELECTROLYTIC
C508	65A452-104-3	100UF +100-10% 15V CAPACITOR CERAMIC
C509	67S201-471-3	.1UF +80-20% 16V Z5U CAPACITOR ELECTROLYTIC
		470UF +100-10% 15V

CIRCUIT NO.	PARTS NO.	DESCRIPTIONS
C510	64S444-472-1	CAPACITOR CERAMIC 4700PF K Z5P 50V
C701	63S107-1	CAPACITOR .1UF M 250V AC
C702	63S107-1	CAPACITOR .1UF M 250V AC
C703	65A306-472-2	CAPACITOR CERAMIC 4700PF ± 20% 400VAC
C704	65A306-472-2	CAPACITOR CERAMIC 4700PF ± 20% 400VAC
C706	65S417-472-1	CAPACITOR CERAMIC 4700PF K Z5F 500V
C707	65S417-472-1	CAPACITOR CERAMIC 4700PF K Z5F 500V
C708	65S417-472-1	CAPACITOR CERAMIC 4700PF K Z5F 500V
C709	65S417-472-1	CAPACITOR CERAMIC 4700PF K Z5F 500V
C710	67D90-19	CAPACITOR ELECTROLYTIC 100UF 200V
C712	67D90-19	CAPACITOR ELECTROLYTIC 100UF 200V
C714	65A2K-561-2A	CAPACITOR CERAMIC 560PF K Z5P 2KV
C716	64A177-23-58	CAPACITOR POLYESTER 0.068UF J 50V
C717	65S450-473-4	CAPACITOR CERAMIC .047UF Z5V 50V
C718	65S450-473-4	CAPACITOR CERAMIC .047UF Z5V 50V
C719	65S450-473-4	CAPACITOR CERAMIC .047UF Z5V 50V
C720	67A301-100-7	CAPACITOR ELECTROLYTIC 10UF +100-10% 50V
C721	65S450-473-4	CAPACITOR CERAMIC .047UF Z5V 50V
C722	67S201-102-3M	CAPACITOR ELECTROLYTIC 1000UF +100-10% 15V
C723	67S201-471-3	CAPACITOR ELECTROLYTIC 470UF +100-10% 15V
C725	65A1M-103-3B	CAPACITOR CERAMIC

CIRCUIT NO.	PARTS NO.	DESCRIPTIONS
C726	65A2M-221-3A	10000PF M Z5U 1KV CAPACITOR CERAMIC
D201	93C64-11H	220PF M Z5U 2KV DIODE 1N4148
D202	93B52-1	DIODE 1A 600V 1N4005
D302	93D39-54	ZENER DIODE 12.7V $\pm$ 5% 0.5W
D302	93C64-11H	DIODE 1N4148
D303	93D60-73	DIODE HER305
D304	93C64-11H	DIODE 1N4148
D305	93D60-73	DIODE HER305
D306	93D60-73	DIODE HER305
D308	93C60-21	DIODE FR155
D309	93C60-53	DIODE RGP 10M
D310	93C60-21	DIODE FR155
D311	93C60-21	DIODE FR155
D403	93C64-11H	DIODE 1N4148
D501	93C60-38	DIODE FR103
D701	93B52-27	DIODE 1N4006
D702	93B52-27	DIODE 1N4006
D703	93B52-27	DIODE 1N4006
D704	93B52-27	DIODE 1N4006
D705	93C60-38	DIODE FR103

CIRCUIT NO.	PARTS NO.	DESCRIPTIONS
D708	93C52-14	DIODE 1N4001
D710	93C60-38	DIODE FR103
D711	93C60-38	DIODE FR103
D712	93D60-73	DIODE HER305
F701	84A38-6	FUSE 250V 1A S-B
F702	84A40-2	FUSE 250V 2.5A F-B
IC201	56A157-1	IC TDA1170N
IC301	56A74LS-221	IC 74LS221
IC401	56A228-1	IC 7406
IC501	56A205-2	IC TBA820M
J702	95S90-22	TIN COATED # 22
J703	95S90-22	TIN COATED # 22
J704	95S90-22	TIN COATED # 22
J706	95S90-22	TIN COATED # 22
J707	95S90-22	TIN COATED # 22
J708	95S90-22	TIN COATED # 22
J709	95S90-22	TIN COATED # 22
J711	95S90-22	TIN COATED # 22
J712	95S90-22	TIN COATED # 22
J713	95S90-22	TIN COATED # 22
J714	95S90-22	TIN COATED

CIRCUIT NO.	PARTS NO.	DESCRIPTIONS
J715	95S90-22	# 22 TIN COATED
J716	95S90-22	# 22 TIN COATED
J717	95S90-22	# 22 TIN COATED
J718	95S90-22	# 22 TIN COATED
J401	95S90-22	# 22 TIN COATED
R311	95S90-22	# 22 TIN COATED
L301	73C253-32	# 22 CHOKER 5.6UH 3A
L302	94A483-9A	COIL HORIZ WIDTH
L303	73C147-16	COIL H. LINEAR
L401	73C145-159	COIL 1.5UH 10%
L501	73C145-471	CHOKER 470UH
L701	73C150-1	LINE CHOKER 1A 15MHx2
L702	73C253-25	CHOKER 44UH
P001	33T3072-10	PLUG PLASTIC 8P
P201	33T3252-1	PIN PLUG 2
P301	33A3252-2	PIN PLUG 3
P302	33T3072-12	PLUG PLASTIC 3P
P501	33T3072-12	PLUG PLASTIC 3P
P502	33T3072-16	PLUG 2P
P703	33T3072-16	PLUG 2P
Q300	57A477-Y	TRANSISTOR 2SC1959(Y)

CIRCUIT NO.	PARTS NO.	DESCRIPTIONS
Q301	57A477-Y	TRANSISTOR 2SC1959(Y)
Q302	57A504-2S	TRANSISTOR BU806 SGS
Q303	57B419-P	TRANSISTOR 2SC945P
Q304	57A490-1	TRANSISTOR BF459
Q305	57A490-1	TRANSISTOR BF459
Q401	57A436-1	TRANSISTOR BSX20
Q402	57A492-1	TRANSISTOR BSX60
Q701	57A486-3	TRANSISTOR TIPL762A
Q702	57A507-1	TRANSISTOR 2SA952M/L
Q703	57A446-1	TRANSISTOR 2SC1213AC
Q704	57A446-1	TRANSISTOR 2SC1213AC
R201	61S172-202-57	RESISTOR CARBON 2K OHM 5% 1/4W
R202	61S172-102-57	RESISTOR CARBON 1K OHM 5% 1/4W
R203	61S172-472-57	RESISTOR CARBON 4.7K OHM 5% 1/4W
R204	61S172-104-57	RESISTOR CARBON 100K OHM 5% 1/4W
R205	61S172-184-57	RESISTOR CARBON 180K OHM 5% 1/4W
R206	61S172-914-57	RESISTOR CARBON 910K OHM 5% 1/4W
R207	61S172-473-57	RESISTOR CARBON 47K OHM 5% 1/4W
R208	61S172-223-57	RESISTOR CARBON 22K OHM 5% 1/4W
R209	61S172-562-57	RESISTOR CARBON 5600 OHM 5% 1/4W
R210	61S175-159-64	RESISTOR CARBON

CIRCUIT NO.	PARTS NO.	DESCRIPTIONS
R211	61S172-682-57	1.5 OHM 5% 1/2W RESISTOR CARBON
R212	61S172-562-57	6.8K OHM 5% 1/4W RESISTOR CARBON
R213	61S172-339-57	5600 OHM 5% 1/4W RESISTOR CARBON
R214	61S172-224-57	3.3 OHM 5% 1/4W RESISTOR CARBON
R301	61S172-202-57	220K OHM 5% 1/4W RESISTOR CARBON
R302	61S172-102-57	2K OHM 5% 1/4W RESISTOR CARBON
R303	61S200-243-57	1K OHM 5% 1/4W RESISTOR CARBON
R304	61S200-472-57	24K OHM 1% 1/4W RESISTOR CARBON
R305	61S172-472-57	4.7K OHM 1% 1/4W RESISTOR CARBON
R306	61S175-331-64	4.7K OHM 5% 1/4W RESISTOR CARBON
R307	61S152-101-59	330 OHM 5% 1/2W RESISTOR METAL FILM
R308	61S172-221-57	100 OHM 5% 2W RESISTOR CARBON
R309	61S175-561-64	220 OHM 5% 1/4W RESISTOR CARBON
R310	61S172-221-57	560 OHM 5% 1/2W RESISTOR CARBON
R313	61S175-470-64	220 OHM 5% 1/4W RESISTOR CARBON
R314	61S172-104-57	47 OHM 5% 1/2W RESISTOR CARBON
R315	61S172-683-57	100K OHM 5% 1/4W RESISTOR CARBON
R317	61S175-470-64	68K OHM 5% 1/4W RESISTOR CARBON
R318	61S152-184-59	47 OHM 5% 1/2W RESISTOR METAL FILM
R319	61S172-334-57	180K OHM 5% 2W RESISTOR CARBON
		330K OHM 5% 1/4W



CIRCUIT NO.	PARTS NO.	DESCRIPTIONS
R320	61S172-334-57	RESISTOR CARBON 330K OHM 5% 1/4W
R321	61S172-272-57	RESISTOR CARBON 2.7K OHM 5% 1/4W
R322	61S172-103-57	RESISTOR CARBON 10K OHM 5% 1/4W
R323	61S175-105-64	RESISTOR CARBON 1MEG OHM 5% 1/2W
R324	61S175-223-64	RESISTOR CARBON 22K OHM 5% 1/2W
R325	61S175-333-64	RESISTOR CARBON 33K OHM 5% 1/2W
R326	61S172-472-57	RESISTOR CARBON 4.7K OHM 5% 1/4W
R327	61S172-104-57	RESISTOR CARBON 100K OHM 5% 1/4W
R328	61S172-564-57	RESISTOR CARBON 560K OHM 5% 1/4W
R402	61S172-331-57	RESISTOR CARBON 330 OHM 5% 1/4W
R403	61S172-331-57	RESISTOR CARBON 330 OHM 5% 1/4W
R405	61S208-121-64	RESISTOR METAL FILM 120 OHM 5% 1W
R407	61S172-560-57	RESISTOR CARBON 56 OHM 5% 1/4W
R411	61S172-391-57	RESISTOR CARBON 390 OHM 5% 1/4W
R412	61S172-221-57	RESISTOR CARBON 220 OHM 5% 1/4W
R413	61S172-339-57	RESISTOR CARBON 3.3 OHM 5% 1/4W
R414	61S175-331-64	RESISTOR CARBON 330 OHM 5% 1/2W
R415	61S153M-471-59	RESISTOR METAL FILM 470 OHM 5% 3W
R501	61S172-103-57	RESISTOR CARBON 10K OHM 5% 1/4W
R502	61S172-471-57	RESISTOR CARBON 470 OHM 5% 1/4W
R503	61S172-560-57	RESISTOR CARBON

CIRCUIT NO.	PARTS NO.	DESCRIPTIONS
R504	61S172-109-57	56 OHM 5% 1/4W RESISTOR CARBON
R505	61S208-471-64	1 OHM 5% 1/4W RESISTOR METAL
R507	61S172-202-57	470 OHM 5% 1W RESISTOR CARBON
R701	61C57-7	2K 5% 1/4W THERMISTOR
R702	61S105-478	5 OHM RESISTOR WIRE WOUND
R703	61S175-154-64	0.47 OHM 10% 5W RESISTOR CARBON
R704	61S152-560-59	150K OHM 5% 1/2W RESISTOR METAL
R705	61S175-154-64	56 OHM 5% 2W RESISTOR CARBON
R706	61S152-209-59	150K OHM 5% 1/2W RESISTOR METAL
R707	61D20-214	2 OHM 5% 2W RESISTOR WIRE WOUND
R708	61S172-151-57	2 OHM 5% 5W RESISTOR CARBON
R709	61S172-102-57	150 OHM 5% 1/4W RESISTOR CARBON
R710	61S172-102-57	1K OHM 5% 1/4W RESISTOR CARBON
R711	61S172-151-57	1K OHM 5% 1/4W RESISTOR CARBON
R712	61S172-332-57	150 OHM 5% 1/4W RESISTOR CARBON
R713	61S172-333-57	3.3K OHM 5% 1/4W RESISTOR CARBON
R714	61S172-102-57	33K OHM 5% 1/4W RESISTOR CARBON
R715	61S175-470-64	1K OHM 5% 1/4W RESISTOR CARBON
R716	61S152-120-59	47 OHM 1% 1/4W RESISTOR METAL
R717	61S172-332-57	12 OHM 5% 2W RESISTOR CARBON
		3.3K OHM 5% 1/4W

CIRCUIT NO.	PARTS NO.	DESCRIPTIONS
R719	61S172-102-57	RESISTOR CARBON 1K OHM 5% 1/4W
R720	61S175-681-64	RESISTOR CARBON 680 OHM 5% 1/2W
SP402	62B2-5	SPARK-GAP
T301	79A315-1	H.O.T. 12V
T701	80A502-1	POWER TRANSFORMER
T702	79A500-1	DRIVER TRANSFORMER
VR201	75D209-15	VARIABLE RESISTOR 200K B
VR202	75D209-15	VARIABLE RESISTOR 200K B
VR203	75A323-104	VARIABLE RESISTOR 100K OHM $\pm$ 20%
VR301	75D209-26	VARIABLE RESISTOR 20KB OHM
VR302	75A323-204	VARIABLE RESISTOR 200K OHM $\pm$ 20%
VR304	75D209-19	VARIABLE RESISTOR 2MEG B
VR701	75A323-501	VARIABLE RESISTOR 500 OHM $\pm$ 20%
ZD301	93C39-52	ZENER DIODE 5.1V $\pm$ 5% 0.5W
ZD401	93C39-52	ZENER DIODE 5.1V $\pm$ 5% 0.5W
ZD709	93C39-79	ZENER DIODE 6.0-6.3/6.12-6.44
ZD713	93D39-71	ZENER DIODE 14.1-14.7V

PARTS ASSEMBLY TABLE

ITEM	Q'TY	DESCRIPTION	PARTS NO.	REMARK
1	1	FRONT PANEL	34E423-5	
2	1	LED PCB	-	
3	1	SCREW	1T421-4-128	
4	1	POWER SWITCH	77A306-3	
5	2	KNOB	33T3262-3	
6	1	VR BRACKET	15T5266-1	
7	2	SCREW	1T421-9-128	
8	2	SCREW	K1S401-805-120	
9	1	SPEAKER	78A297-1	
10	2	SCREW	K1S404-603-128	
11	1	SIDE BRACKET(R)	15T5267-2	
12	2	SCREW	K1S401-805-120	
13	1	SIDE BRACKET(L)	15T5267-1	
14	2	SCREW	K1S401-805-120	
15	1	BASE FASTENER	33T3264-1	
16	1	BOTTOM BOARD	34E425-7	
17	2	SPEED NUT	2C9-77-128	
18	1	BOTTOM BASE	34E426-4	
19	4	WASHER	4C1-44-128	
20	4	RUBBER FOOT	12T308-2	
21	4	SCREW	K1S404-603-128	
22	1	RUBBER WASHER	5B38-1	
23	1	WASHER	4C1-97-128	
24	1	SCREW	K1S350-25-128	
25	1	LINE CORD CLAMP	11D27-3	
26	1	LINE CORD CLAMP	11D27-3	
27	1	LINE CORD	89A171-8	
28	1	SIGNAL CORD		
29	3	SCREW	K1S401-805-120	
30	1	CRT	97A221-11	
31	4	LOCK WASHER	3C1-111-46	
32	4	SCREW	K1S401-806-128	
33	1	DAG SPRING	19B199-6	
34	6	SCREW	K1S401-805-120	
35	12	RUBBER WASHER	5B38-10	
36	1	MAIN PCB		
37	6	RUBBER WASHER	5B38-11	
38	1	BACK COVER	34E424-6	
39	2	SCREW	K1S401-805-120	
40	2	SCREW	G1S140-18-120	

For Service Manuals  
 contact  
**MAURITRON SERVICES**  
 8 Cherry Tree Road, Chinnor  
 Oxfordshire, OX9 4QY  
 Tel (01844) 351684  
 Fax (01844) 352554

For Service Manuals  
 contact  
**MAURITRON SERVICES**  
 8 Cherry Tree Road, Chinnor  
 Oxfordshire, OX9 4QY  
 Tel (01844) 351684  
 Fax (01844) 352554

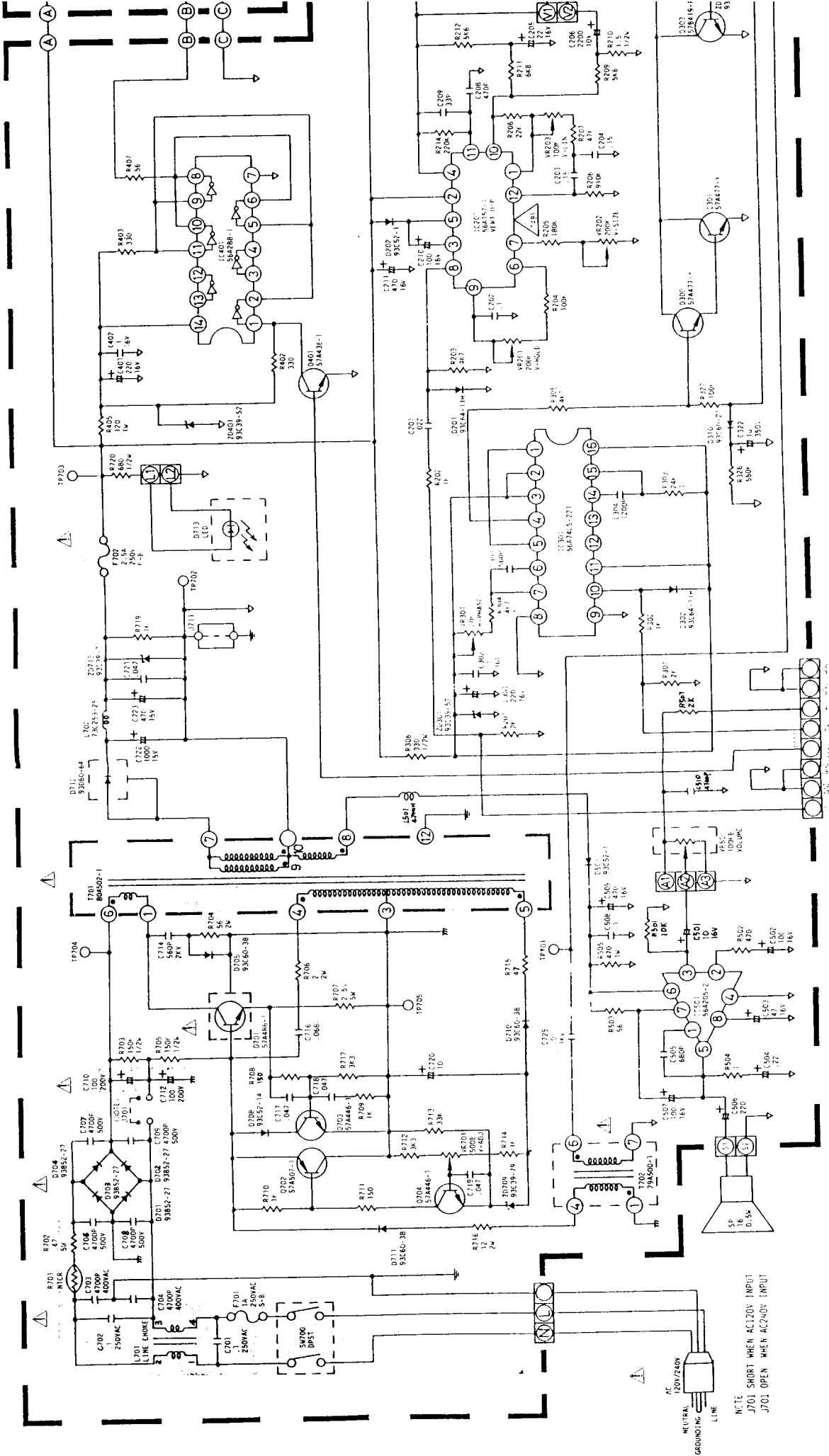

NOTE  
 J701 SHORT WHEN AC120V INPUT  
 J701 OPEN WHEN AC240V INPUT

SCHEMATIC DIAGRAM

For Service Manuals  
**MAURITRON SERVICES**  
 8 Cherry Tree Road, Chinnor,  
 Oxfordshire, OX9 4QY.  
 Tel: (01844) 351684  
 Fax: (01844) 352554

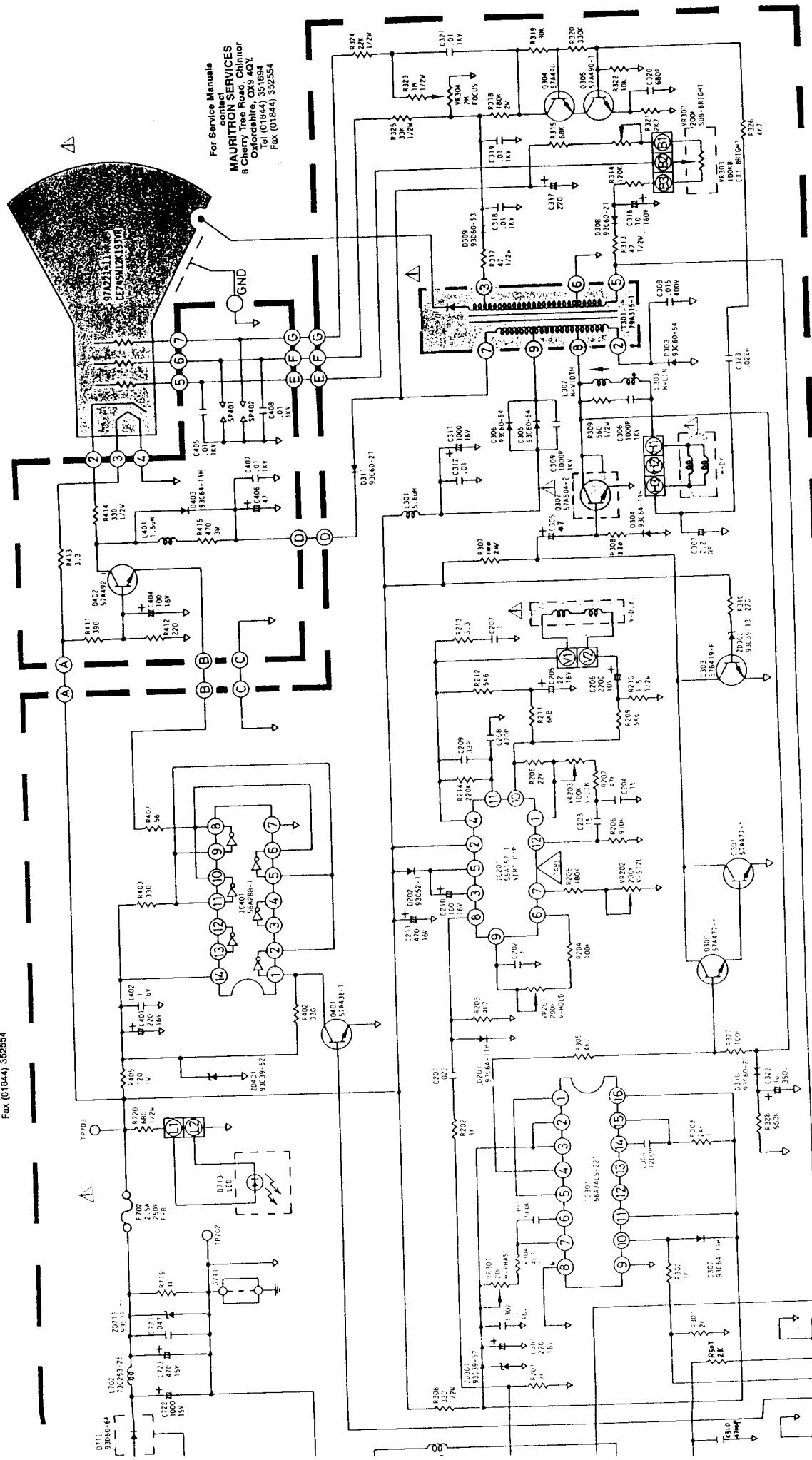

For Service Manuals  
 contact  
**MAURITRON SERVICES**  
 8 Cherry Tree Road, Chinnor,  
 Oxfordshire, OX9 4QY.  
 Tel: (01844) 351684  
 Fax: (01844) 352554

For Service Manuals  
 contact  
**MAURITRON SERVICES**  
 8 Cherry Tree Road, Chinnor  
 Oxfordshire, OX9 4QY.  
 Tel (01844) 351694  
 Fax (01844) 352554

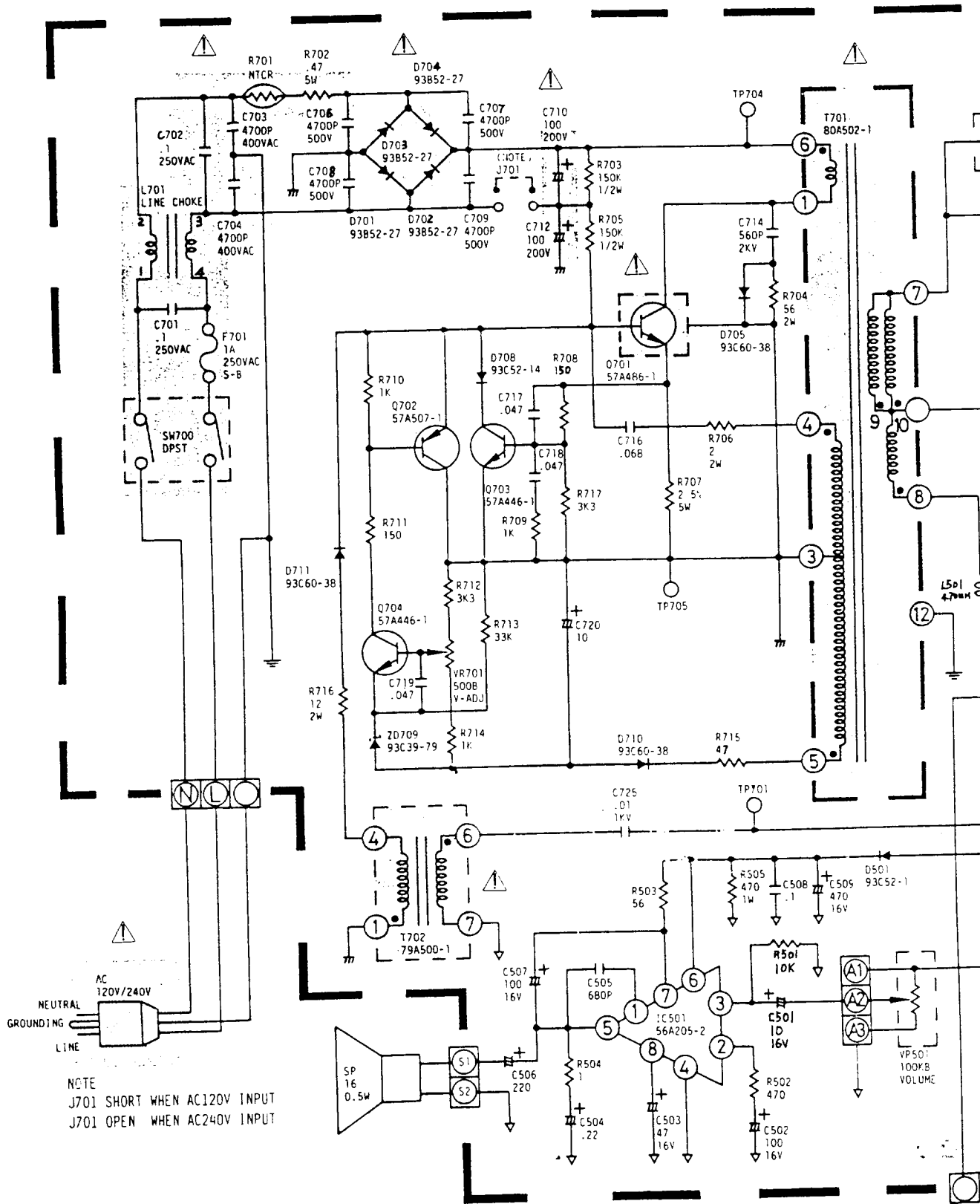

NOTE  
 J701 SHORT WHEN AC120V INPUT  
 J701 OPEN WHEN AC240V INPUT

SCHEMATIC DIAGRAM

Manuals  
 Contact  
**MAURITRON SERVICES**  
 Road, Chinnor  
 a, OX9 4QY.  
 4) 351694  
 4) 352554

For Service Manuals  
 contact  
**MAURITRON SERVICES**  
 8 Cherry Tree Road, Chinnor  
 Oxfordshire, OX9 4QY.  
 Tel (01844) 351694  
 Fax (01844) 352554

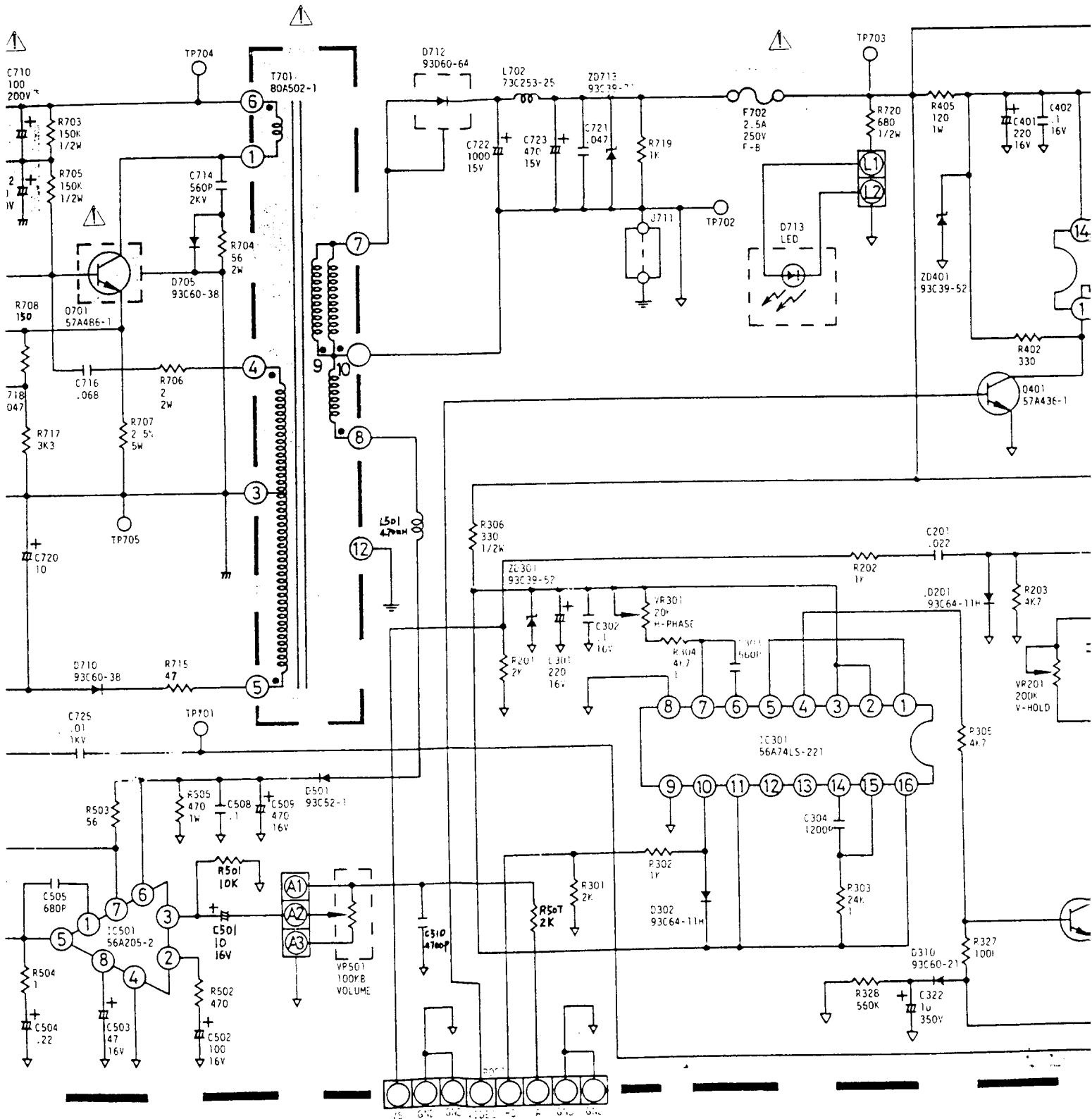



For Service Manuals  
 contact  
**MAURITRON SERVICES**  
 8 Cherry Tree Road, Chinnor  
 Oxfordshire, OX9 4QY.  
 Tel (01844) 351694  
 Fax (01844) 352554

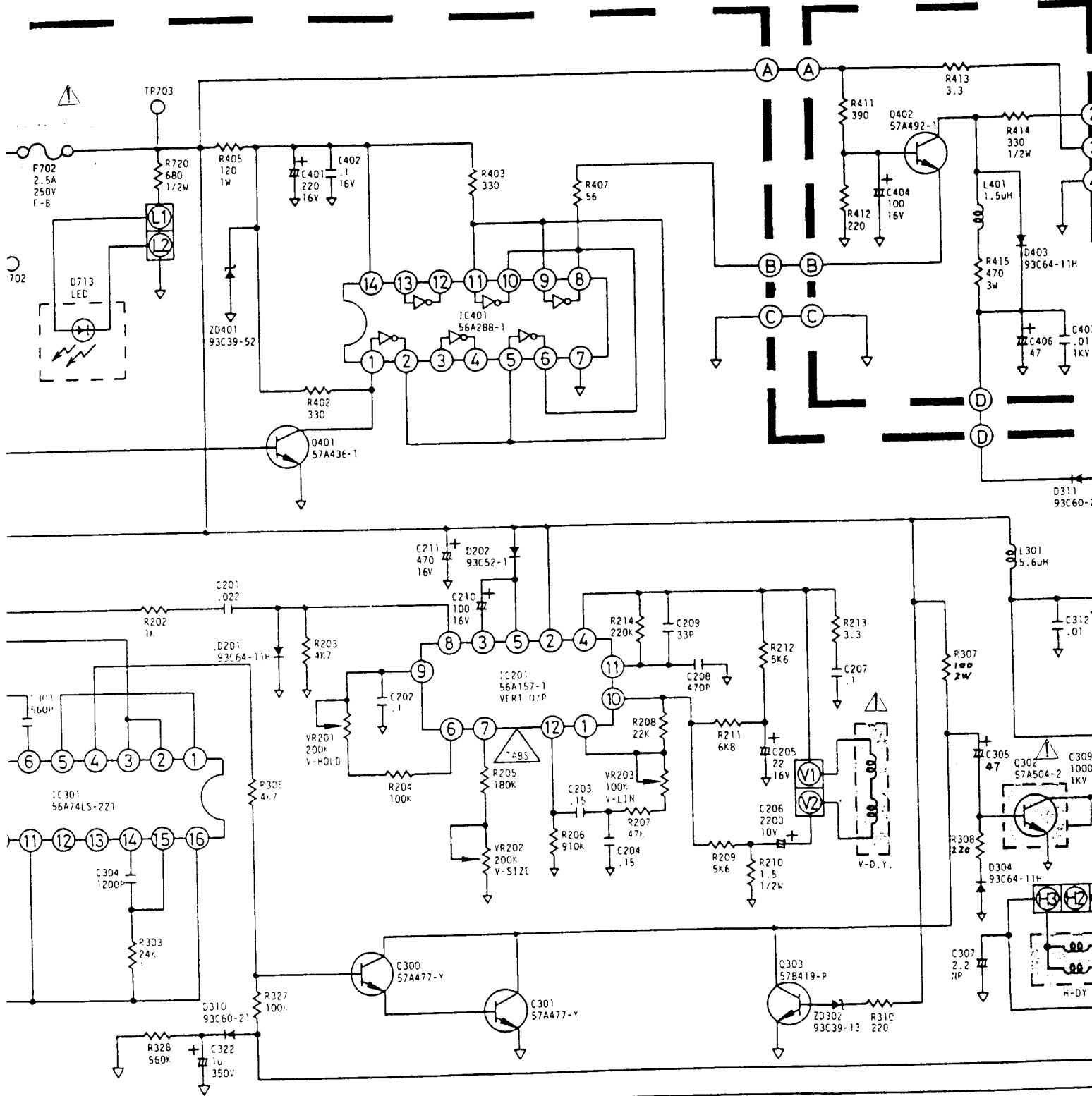

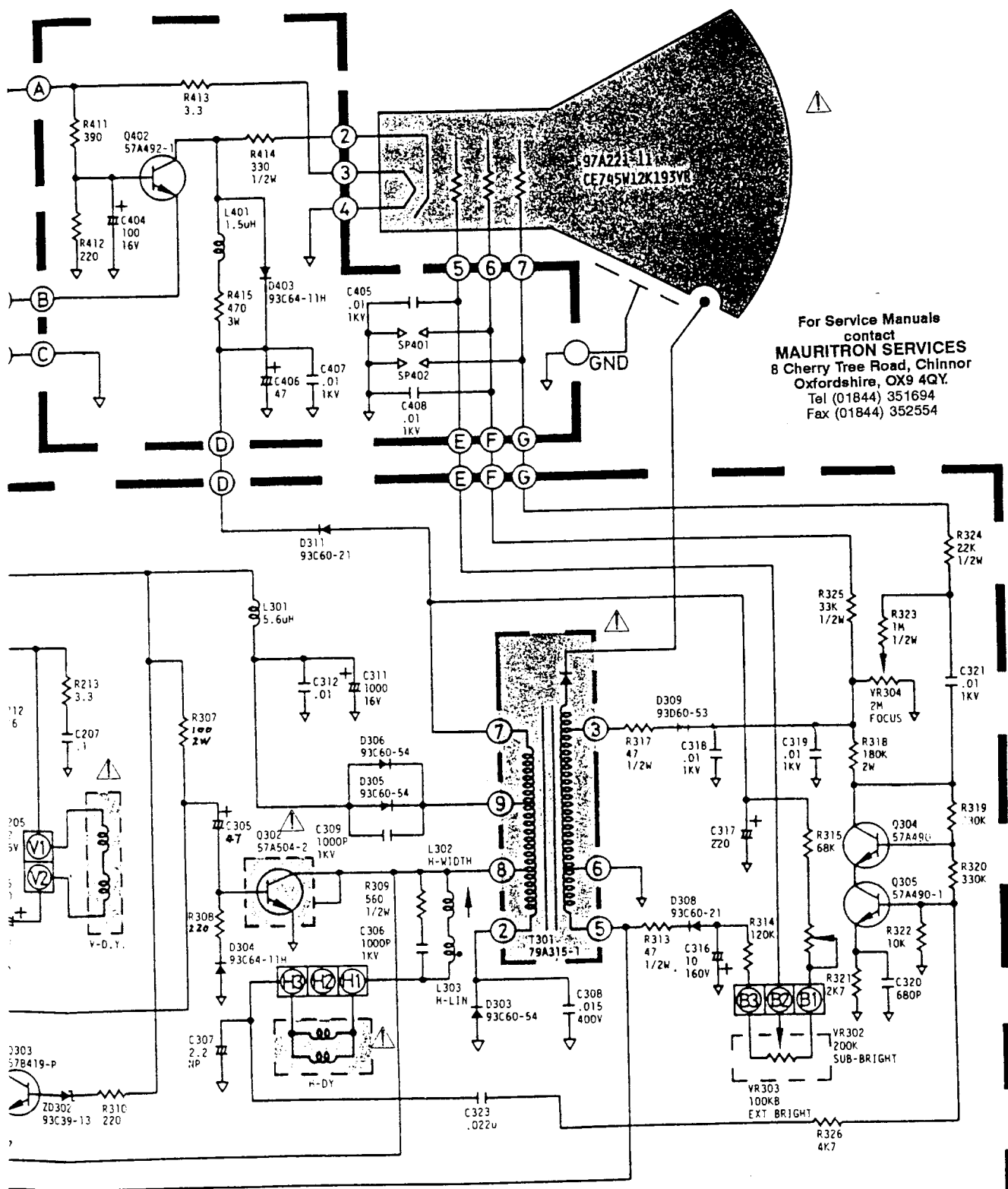

For Service Manuals  
 contact  
**MAURITRON SERVICES**  
 8 Cherry Tree Road, Chinnor  
 Oxfordshire, OX9 4QY.  
 Tel (01844) 351694  
 Fax (01844) 352554

PARTS		ASSEMBLY		TABLE	
ITEM	QTY	DESCRIPTION	PARTS NO	REMARK	
1	1	FRONT PANEL	34E423.5		
2	1	LED PCB	17421.4.128		
3	1	SCREW	77A306.3		
4	1	POWER SWITCH	181502.3		
5	1	ARMOR	181502.3		
6	2	WASHER	17421.4.1134		
7	2	SCREW	K1S401.805.120		
8	1	SPEAKER	78A497.1		
9	10	SCREW	K1S404.603.128		
10	2	SIDE BRACKET (R)	1515267.2		
11	2	SCREW	K1S401.805.120		
12	2	SIDE BRACKET (L)	1515267.1		
13	1	SCREW	K1S401.805.120		
14	2	BASE FASTENER	33T2264.1		
15	1	BOTTOM BOARD	34E425.7		
16	2	SPEED NUT	259.72.128		
17	1	BOTTOM BASE	34E426.4		
18	1	WASHER	4C1.44.128		
19	4	RUBBER FOOT	K1S403.09.2		
20	4	SCREW	K1S403.118		
21	1	RUBBER WASHER	4C1.97.128		
22	1	WASHER	K1S360.25.128		
23	1	SCREW	11D27.3		
24	1	LINE CORD CLAMP	11D27.3		
25	1	LINE CORD	89A171.8		
26	1	SIGNAL CORD	K1S401.805.120		
27	3	SCREW	97A221.1.1		
28	1	ORT	3C1.111.46		
29	4	LOCK WASHER	K1S401.805.128		
30	1	SCREW	196199.6		
31	1	DAG SPRING	K1S401.805.120		
32	6	SCREW	5838.11		
33	1	RUBBER WASHER	34E424.6		
34	1	MAIN PCB	K1S401.805.120		
35	1	RUBBER WASHER	34E424.6		
36	1	RUBBER WASHER	34E424.6		
37	1	SCREW	61S140.18.120		
38	2	SCREW	61S140.18.120		
39	2	SCREW	61S140.18.120		
40	2	SCREW	61S140.18.120		

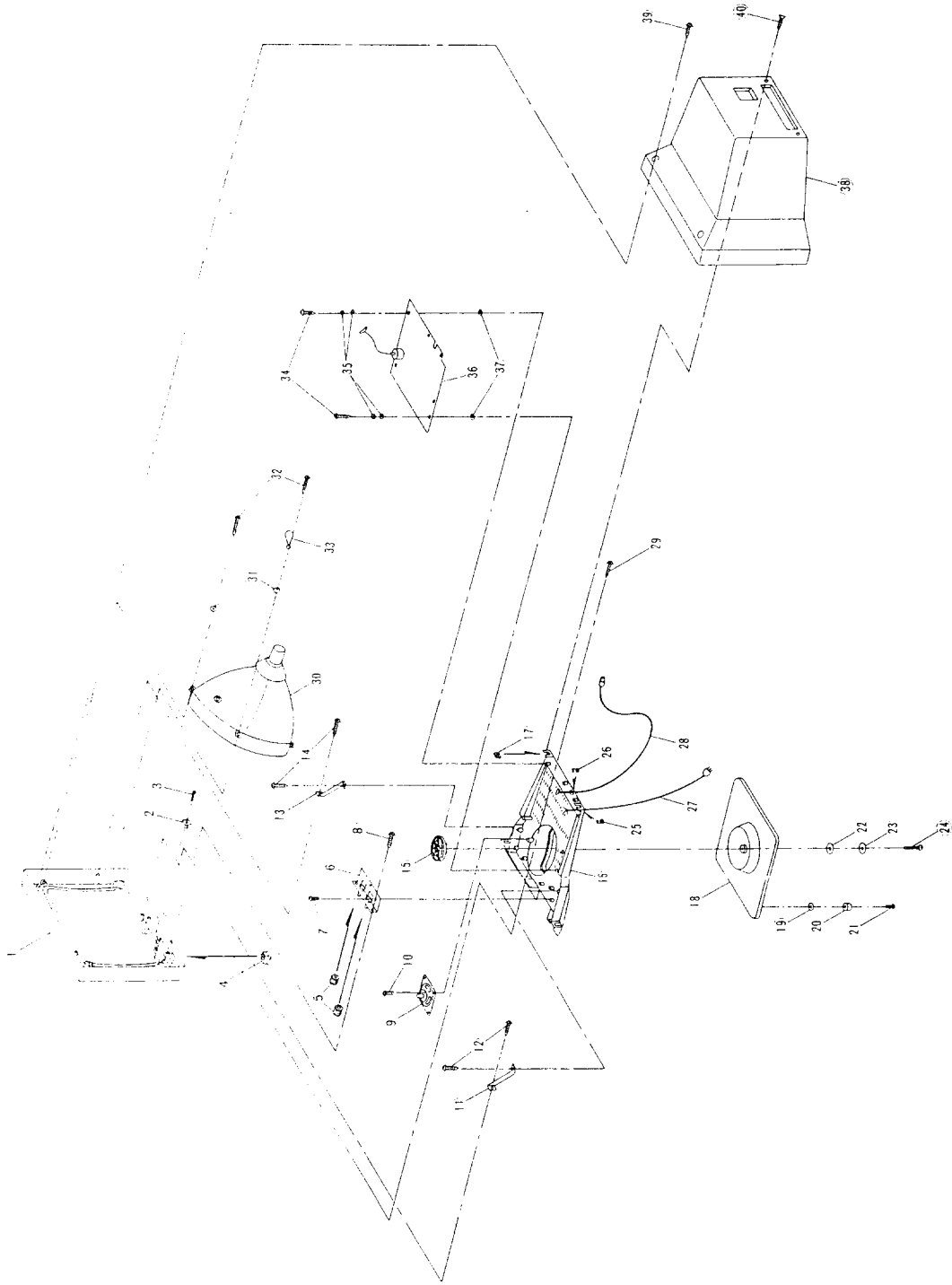

EXPLODED VIEW