

CECHG series

SM-PS3-0093E-02

PLAYSTATION® 3 SEM-001
BOARD SERVICE MANUAL 2nd edition Level 3

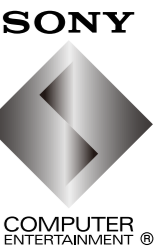

PLAYSTATION 3

Sony Computer Entertainment Inc.
CS Department
Published in Japan © 2007. 10

SAFETY CHECK-OUT

After correcting the original service problem, perform the following safety checks before releasing the set to the customer:

1. Check the area of your repair for unsoldered or poorly soldered connections. Check the entire board surface for solder splashes and bridges.
2. Check the interboard wiring to ensure that no wires are “pinched” or contact high-wattage resistors.
3. Look for unauthorized replacement parts, particularly transistors, that were installed during a previous repair. Point them out to the customer and recommend their replacement.
4. Look for parts which, though functioning, show obvious signs of deterioration. Point them out to the customer and recommend their replacement.
5. Check the power cable for cracks and abrasion. Recommend the replacement of any such power cable to the customer.
6. Check the B+ voltage to see it is at the values specified.
7. Check the metal trim, “metallized” knobs, screws, and all other exposed metal parts for AC leakage. Check leakage as described below.

CAUTION:

The use of optical instruments with this product will increase eye hazard.

CAUTION

Use of controls or adjustments or performance of procedures other than those specified herein may result in hazardous radiation exposure.

WARNING!!

WHEN SERVICING, DO NOT APPROACH THE LASER EXIT WITH THE EYE TOO CLOSELY. IN CASE IT IS NECESSARY TO CONFIRM LASER BEAM EMISSION, BE SURE TO OBSERVE FROM A DISTANCE OF MORE THAN 25 cm FROM THE SURFACE OF THE OBJECTIVE LENS ON THE OPTICAL PICK-UP BLOCK.

LEAKAGE TEST

The AC leakage from any exposed metal part to earth ground and from all exposed metal parts to any exposed metal part having a return to chassis, must not exceed 0.5 mA (500 microamperes.).

Leakage current can be measured by any one of three methods.

1. A commercial leakage tester, such as the Simpson 229 or RCA WT-540A. Follow the manufacturers’ instructions to use these instruments.
2. A battery-operated AC milliammeter. The Data Precision 245 digital multimeter is suitable for this job.
3. Measuring the voltage drop across a resistor by means of a VOM or battery-operated AC voltmeter. The “limit” indication is 0.75 V, so analog meters must have an accurate low-voltage scale. The Simpson 250 and Sanwa SH-63Trd are examples of a passive VOM that is suitable. Nearly all battery operated digital multimeters that have a 2 V AC range are suitable. (See Fig. A)

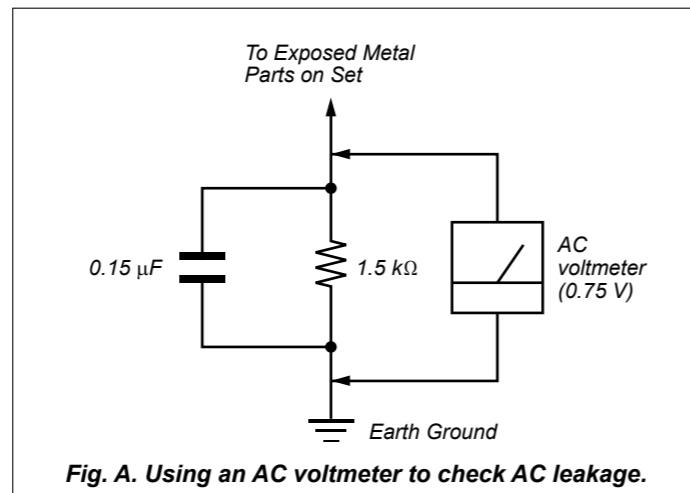

SAFETY-RELATED COMPONENT WARNING!!

COMPONENTS IDENTIFIED BY MARK \triangle OR DOTTED LINE WITH MARK \triangle ON THE SCHEMATIC DIAGRAMS AND IN THE PARTS LIST ARE CRITICAL TO SAFE OPERATION. REPLACE THESE COMPONENTS WITH SONY PARTS WHOSE PART NUMBERS APPEAR AS SHOWN IN THIS MANUAL OR IN SUPPLEMENTS PUBLISHED BY SONY.

ATTENTION AU COMPOSANT AYANT RAPPORT À LA SÉCURITÉ!!

LES COMPOSANTS IDENTIFIÉS PAR UNE MARQUE \triangle SUR LES DIAGRAMMES SCHÉMATIQUES ET LA LISTE DES PIÈCES SONT CRITIQUES POUR LA SÉCURITÉ DE FONCTIONNEMENT. NE REMPLACER CES COMPOSANTS QUE PAR DES PIÈCES SONY DONT LES NUMÉROS SONT DONNÉS DANS CE MANUEL OU DANS LES SUPPLÉMENTS PUBLIÉS PAR SONY.

SPECIAL COMPONENT NOTICE

The components identified by mark \triangle contain confidential information. Strictly follow the instructions whenever the components are repaired and/or replaced.

CAUTION

Ensure that this product is disconnected from the power plug before the laser protective housing is removed.

CLASS 1M LASER RADIATION WHEN OPEN DO NOT VIEW DIRECTLY WITH OPTICAL INSTRUMENTS.

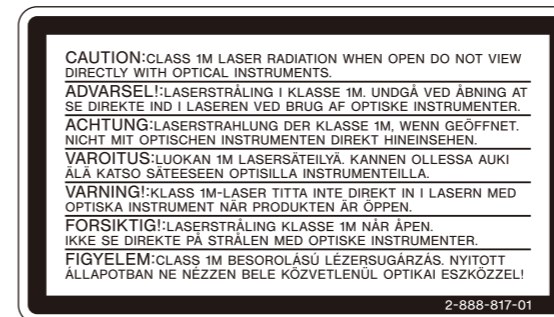

This label is located on the BD/DVD/CD Drive laser protective housing inside the enclosure.

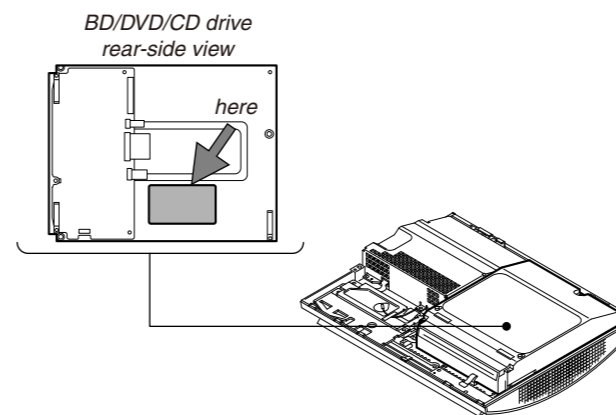

CAUTION

Risk of Explosion if Battery is replaced by an Incorrect Type. Dispose of Used Batteries According to the Instructions.

Lithium Batteries

If an equipment is provided with a replaceable lithium battery, the following applies:

- if the battery is placed in an OPERATOR ACCESS AREA, there shall be a warning close to the battery or in both the operating and the service instructions:
- if the battery is placed elsewhere in the equipment, there shall be a warning close to the battery or in the service instructions.

TABLE OF CONTENTS

1. CIRCUIT DIAGRAM

1-1. CWI-002 Board (1/3) 1-2
 1-2. CWI-002 Board (2/3) 1-3
 1-3. CWI-002 Board (3/3) 1-4
 1-4. SEM-001 Board (1/20) 1-5
 1-5. SEM-001 Board (2/20) 1-6
 1-6. SEM-001 Board (3/20) 1-7
 1-7. SEM-001 Board (4/20) 1-8
 1-8. SEM-001 Board (5/20) 1-9
 1-9. SEM-001 Board (6/20) 1-10
 1-10. SEM-001 Board (7/20) 1-11
 1-11. SEM-001 Board (8/20) 1-12
 1-12. SEM-001 Board (9/20) 1-13
 1-13. SEM-001 Board (10/20) 1-14
 1-14. SEM-001 Board (11/20) 1-15
 1-15. SEM-001 Board (12/20) 1-16
 1-16. SEM-001 Board (13/20) 1-17

1-17. SEM-001 Board (14/20) 1-18
 1-18. SEM-001 Board (15/20) 1-19
 1-19. SEM-001 Board (16/20) 1-20
 1-20. SEM-001 Board (17/20) 1-21
 1-21. SEM-001 Board (18/20) 1-22
 1-22. SEM-001 Board (19/20) 1-23
 1-23. SEM-001 Board (20/20) 1-24

2. PRINTED WIRING BOARDS

2-1. CWI-002 Board (Side A) 2-1
 2-2. CWI-002 Board (Side B) 2-2
 2-3. SEM-001 Board (Side A) 2-3
 2-4. SEM-001 Board (Side B) 2-4

3. ELECTRICAL PARTS LIST

CWI-002 Board 3-1
 SEM-001 Board 3-1

**SECTION 1
CIRCUIT DIAGRAM**

Note on Schematic Diagram:

- All capacitors are in μF unless otherwise noted.
pF: $\mu\mu\text{F}$ 50 WV or less are not indicated except for electrolytics and tantalums.
- All resistors are in Ω and $1/4$ W or less unless otherwise specified.
- % : indicates tolerance.

Note:

The components identified by mark \triangle or dotted line with mark \triangle are critical for safety. Replace only with part number specified.

Note:

Les composants identifiés par une marque \triangle sont critiques pour la sécurité. Ne les remplacer que par une pièce portant le numéro spécifié.

1-1. CWI-002 BOARD (1/3)

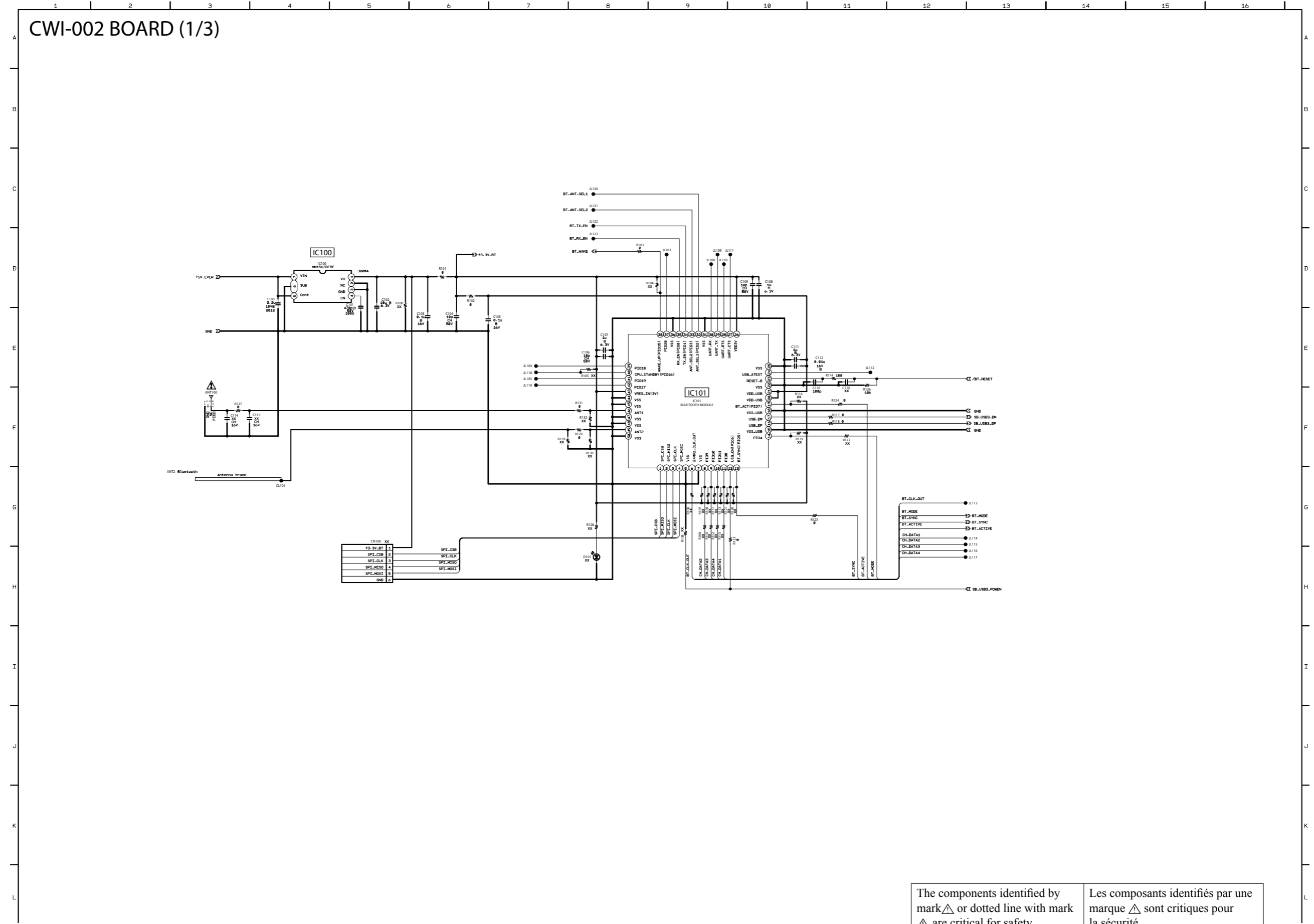

<p>The components identified by mark \triangle or dotted line with mark \triangle are critical for safety. Replace only with part number specified.</p>	<p>Les composants identifiés par une marque \triangle sont critiques pour la sécurité. Ne les remplacer que par une pièce portant le numéro spécifié.</p>
---	--

1-2. CWI-002 BOARD (2/3)

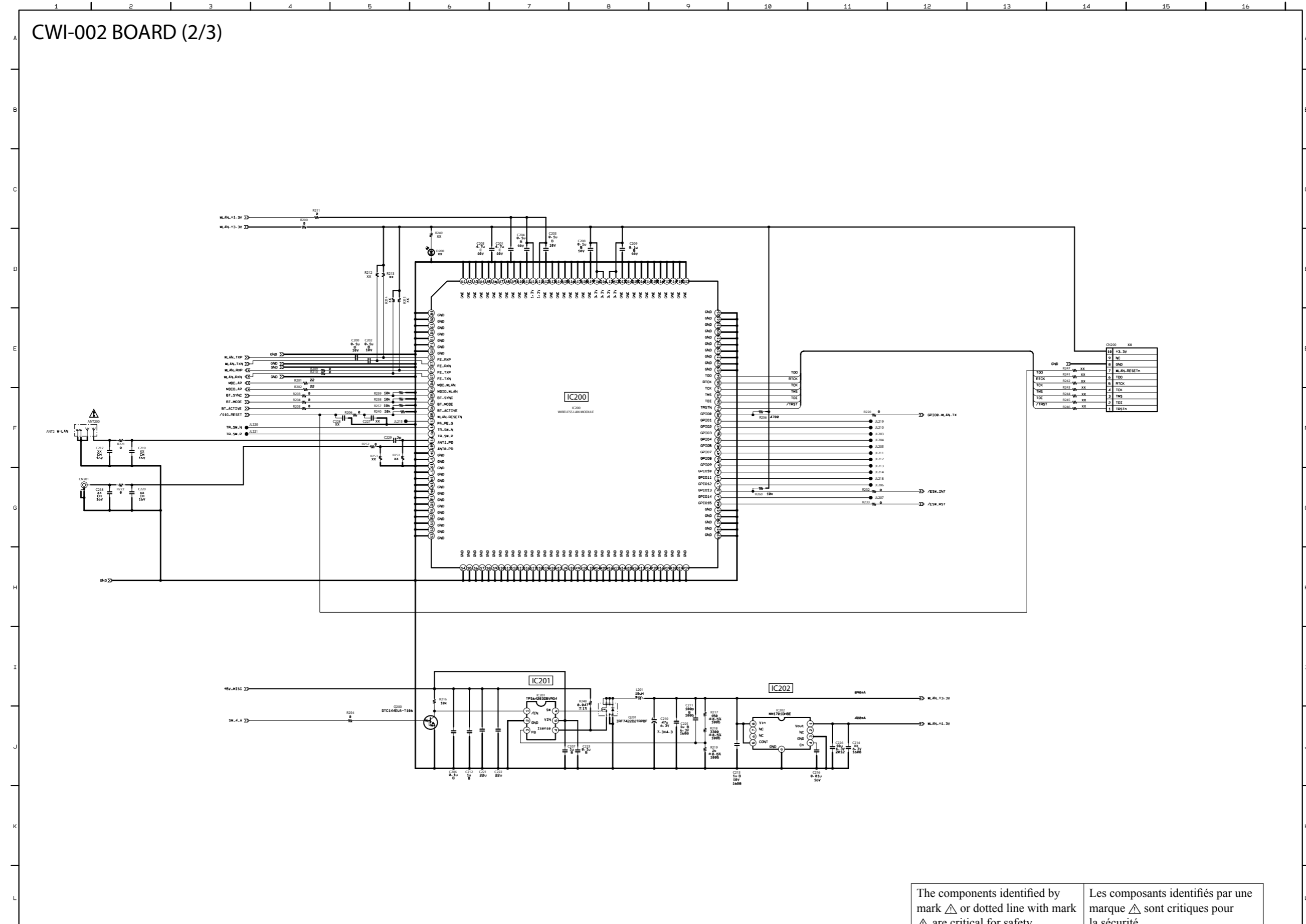

The components identified by mark \triangle or dotted line with mark \triangle are critical for safety. Replace only with part number specified.

Les composants identifiés par une marque \triangle sont critiques pour la sécurité. Ne les remplacer que par une pièce portant le numéro spécifié.

1-3. CWI-002 BOARD (3/3)

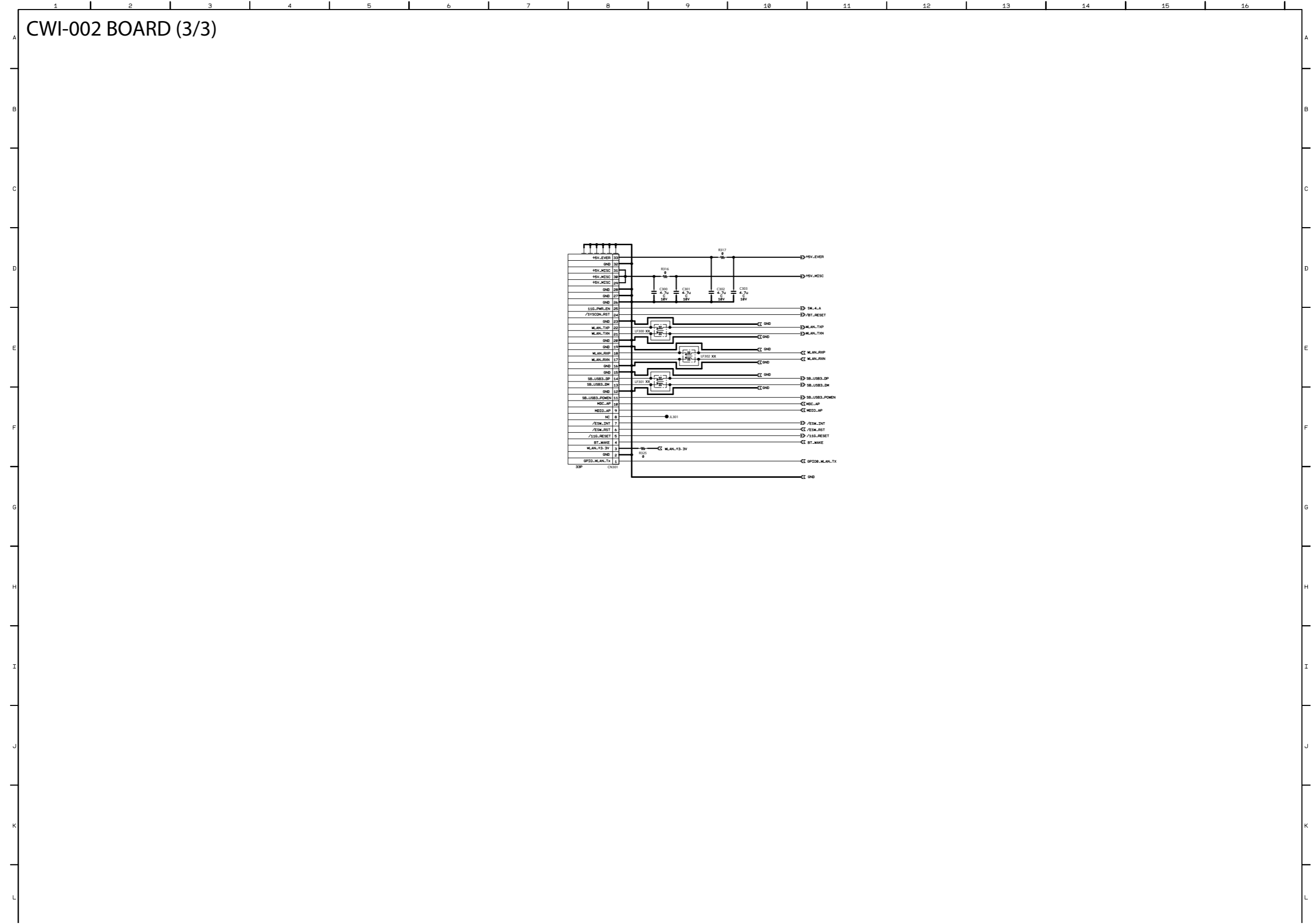

1-5. SEM-001 BOARD (2/20)

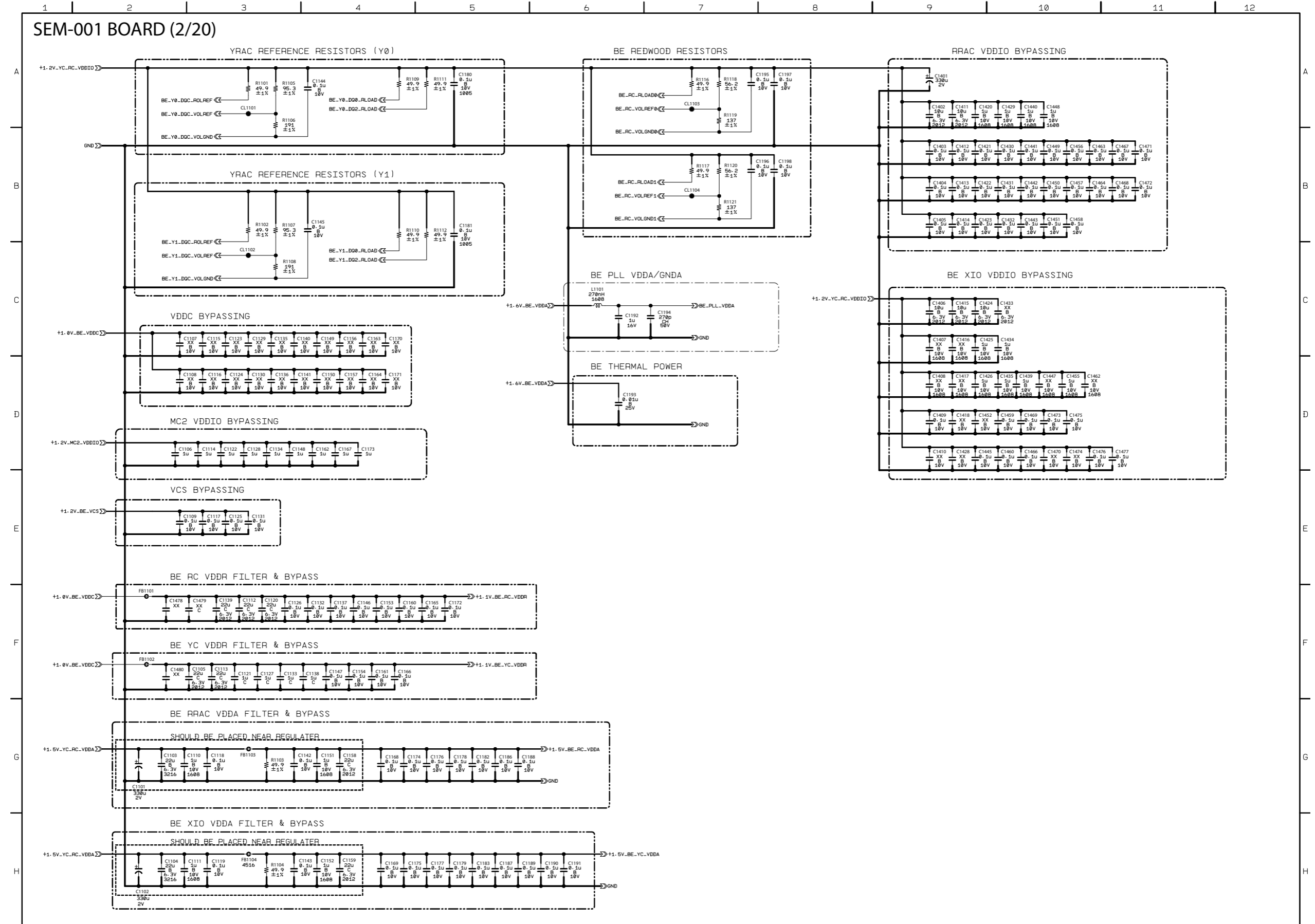

1-6. SEM-001 BOARD (3/20)

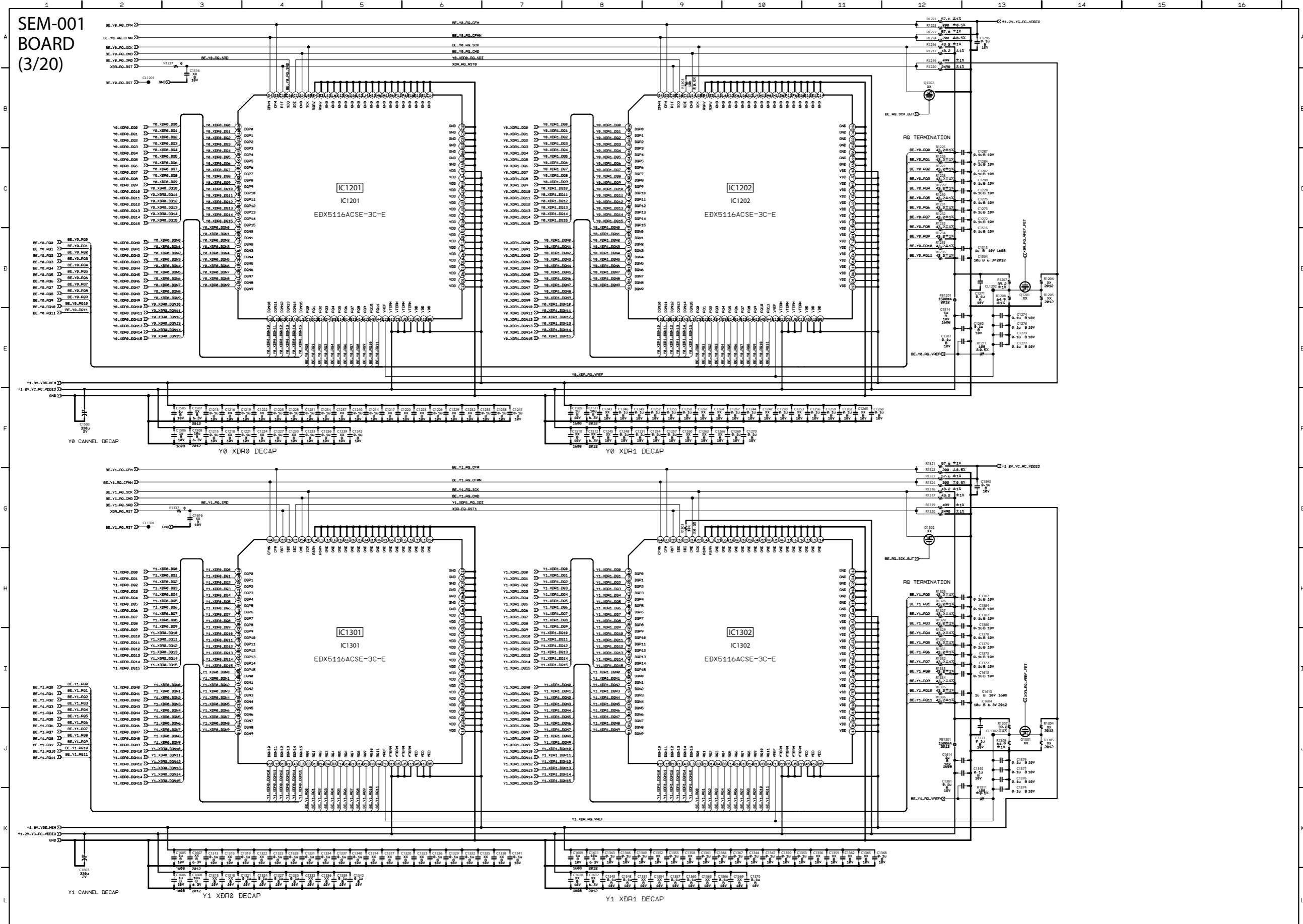

1-7. SEM-001 BOARD (4/20)

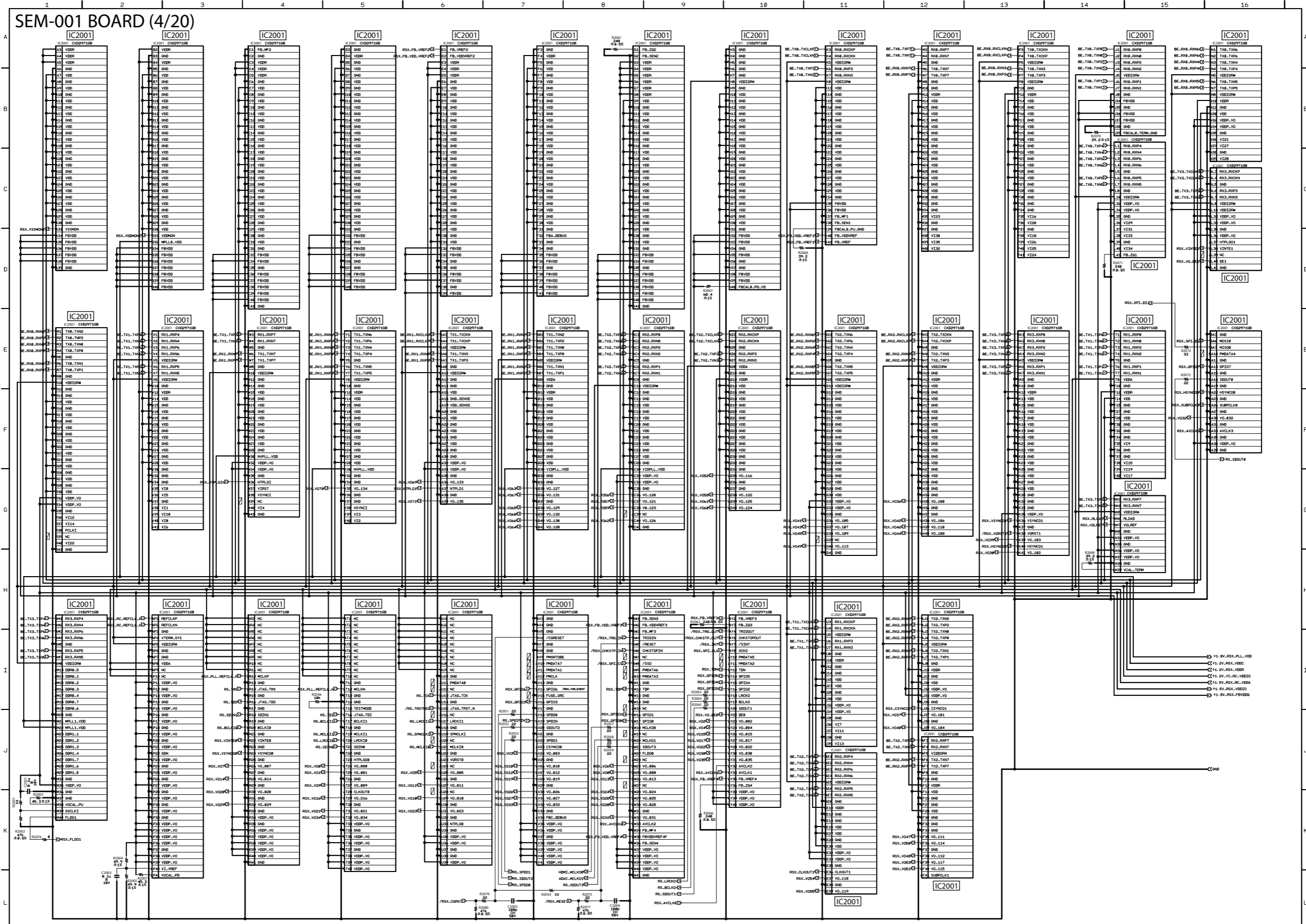

1-8. SEM-001 BOARD (5/20)

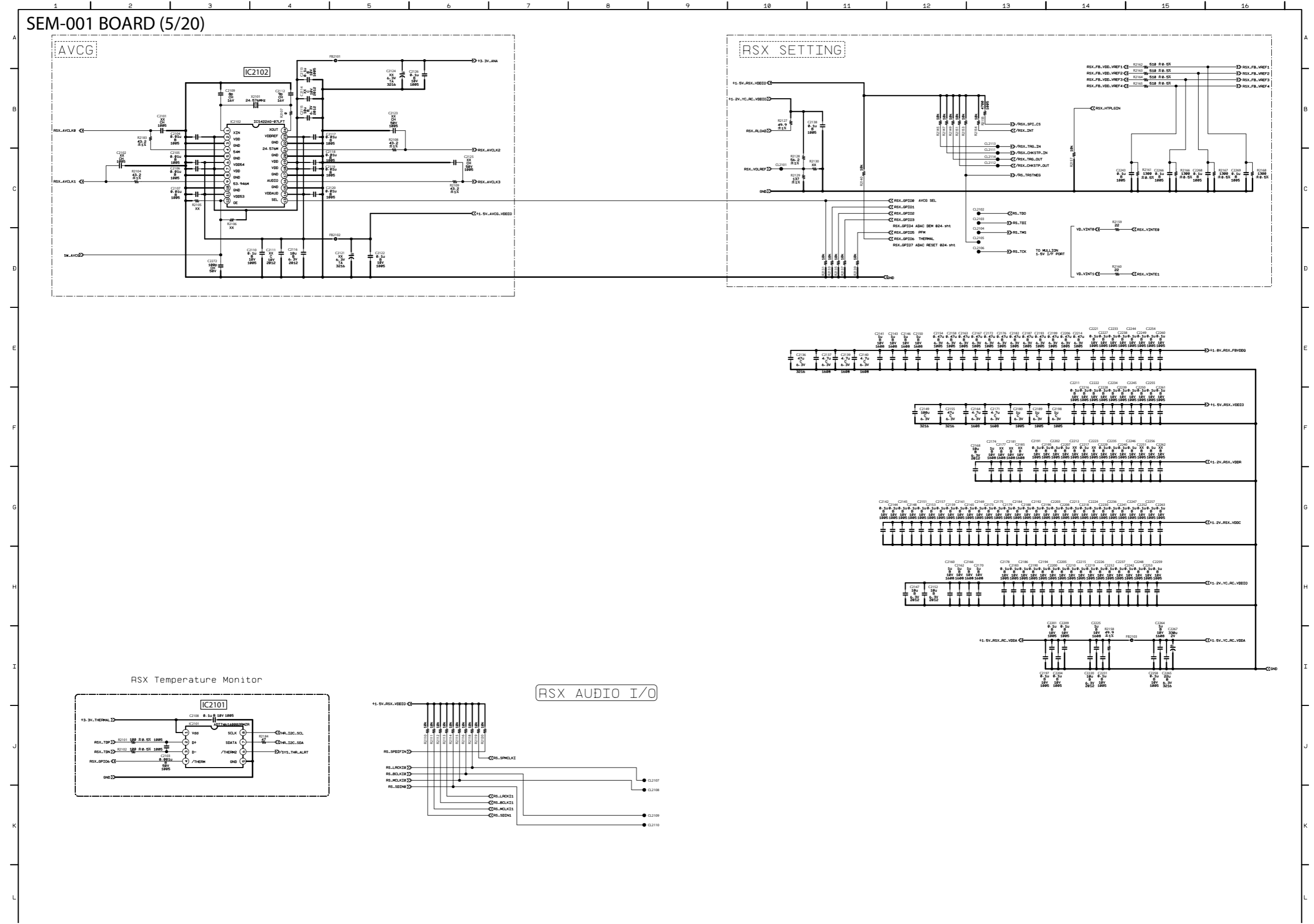

1-9. SEM-001 BOARD (6/20)

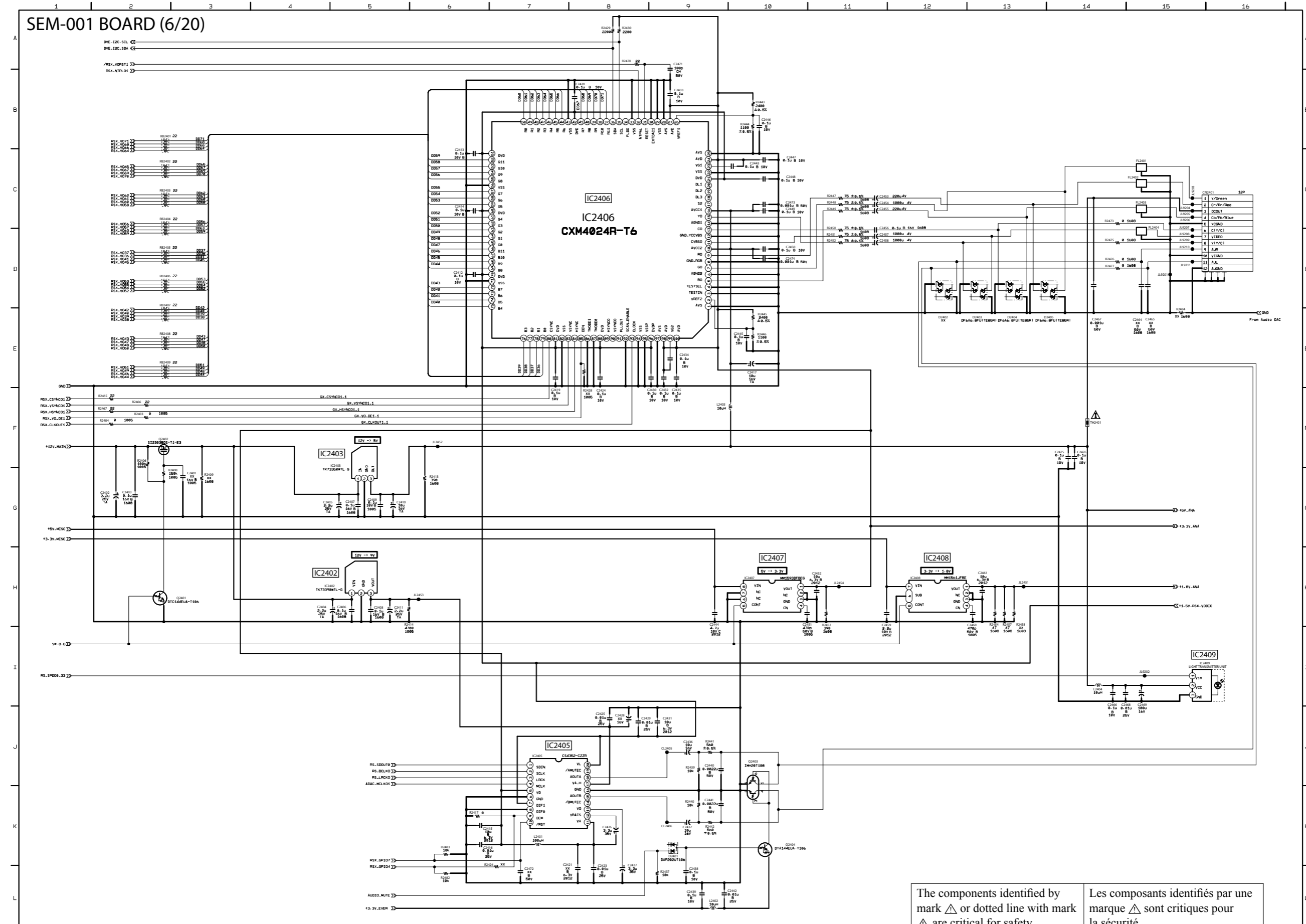

<p>The components identified by mark \triangle or dotted line with mark \triangle are critical for safety. Replace only with part number specified.</p>	<p>Les composants identifiés par une marque \triangle sont critiques pour la sécurité. Ne les remplacer que par une pièce portant le numéro spécifié.</p>
---	--

1-10. SEM-001 BOARD (7/20)

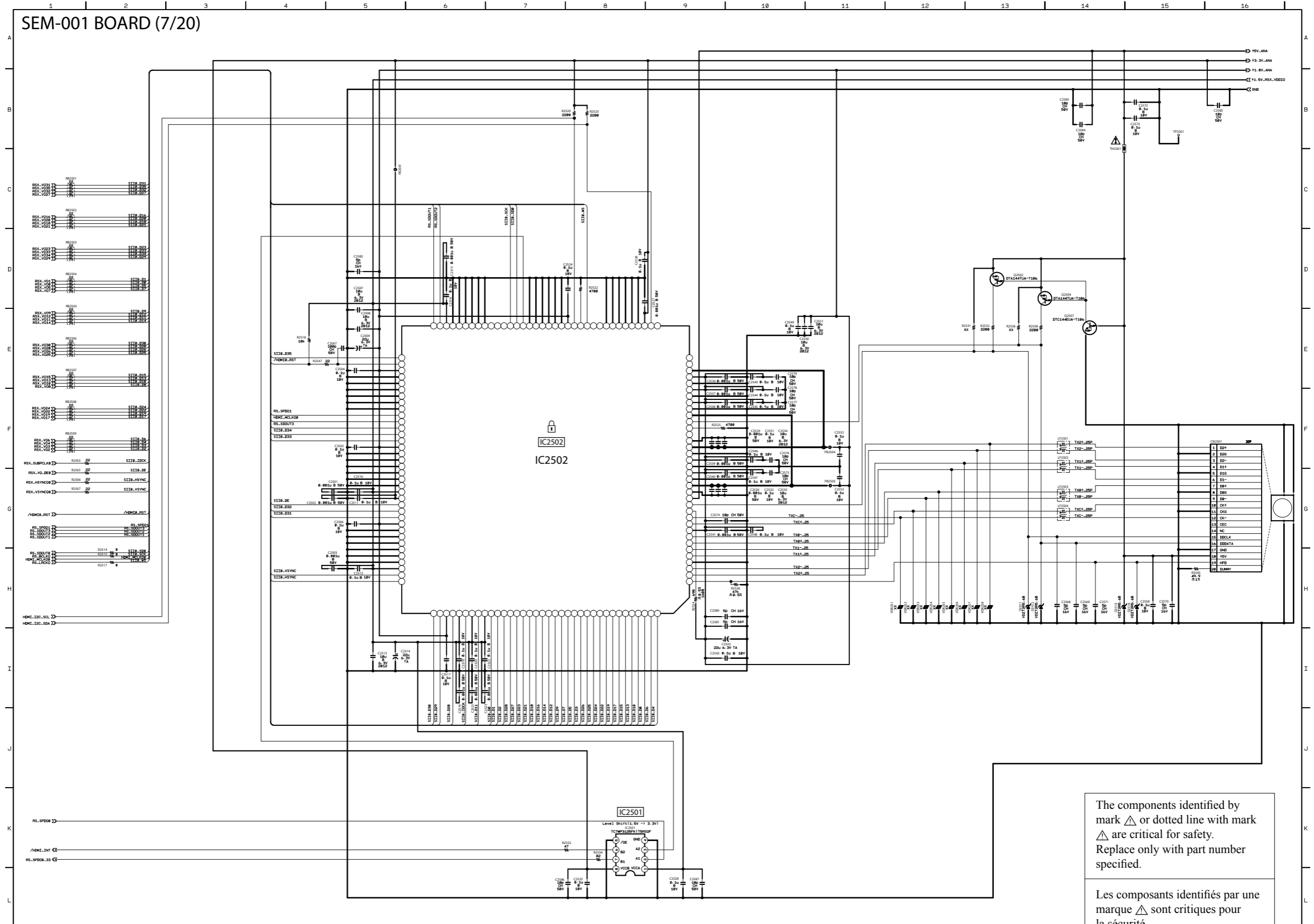

1-11. SEM-001 BOARD (8/20)

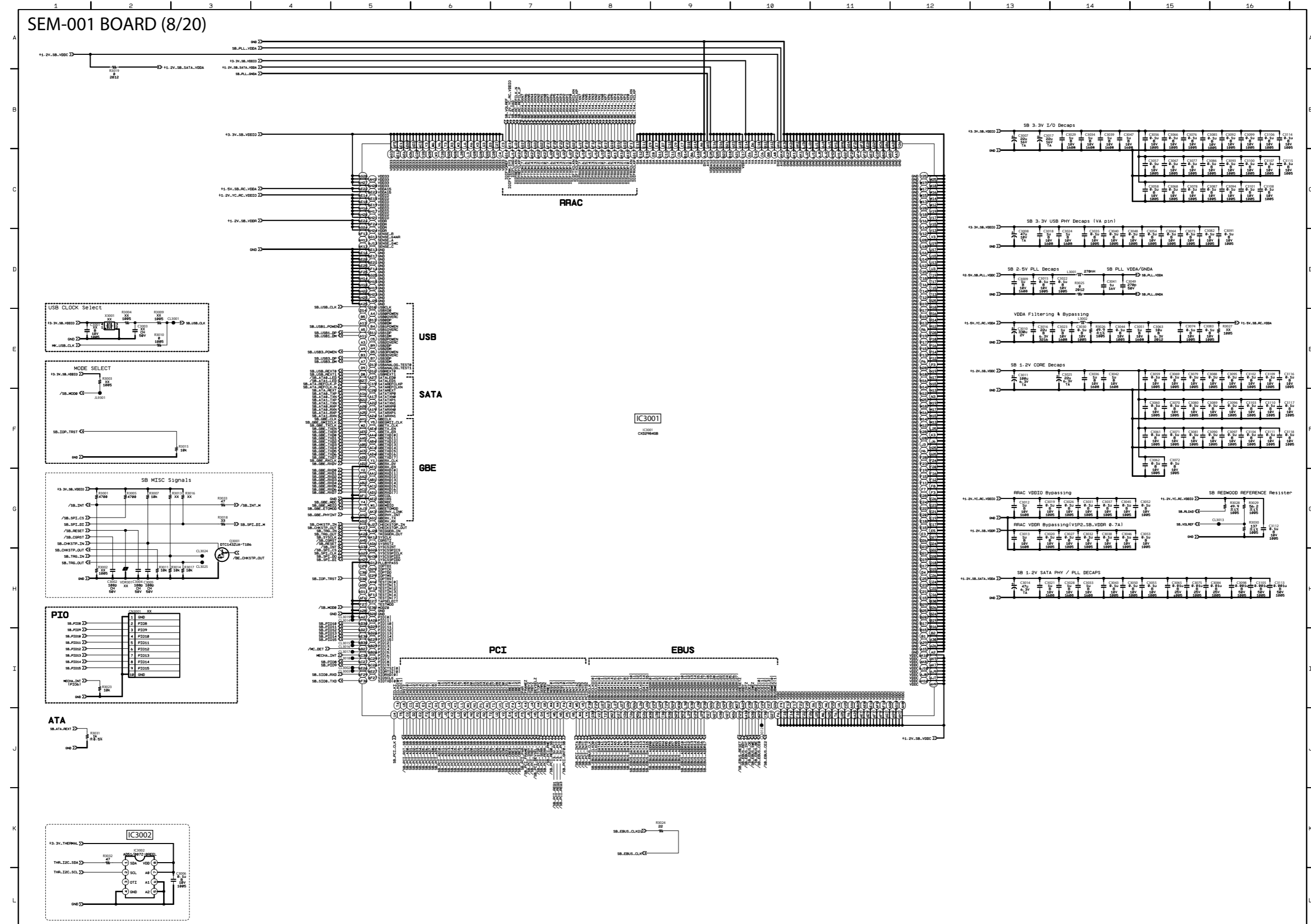

1-12. SEM-001 BOARD (9/20)

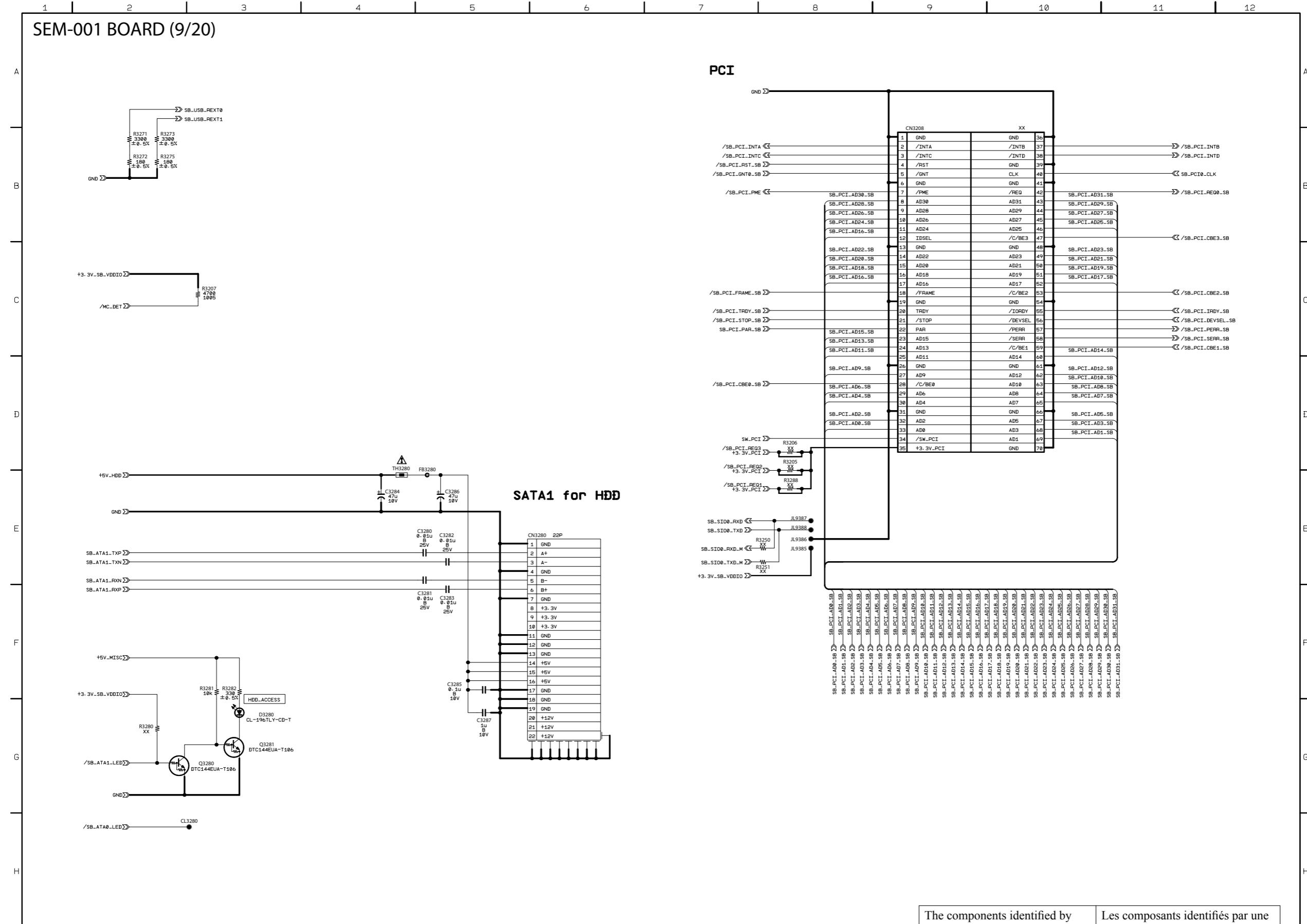

The components identified by mark \triangle or dotted line with mark \triangle are critical for safety. Replace only with part number specified.

Les composants identifiés par une marque \triangle sont critiques pour la sécurité. Ne les remplacer que par une pièce portant le numéro spécifié.

1-13. SEM-001 BOARD (10/20)

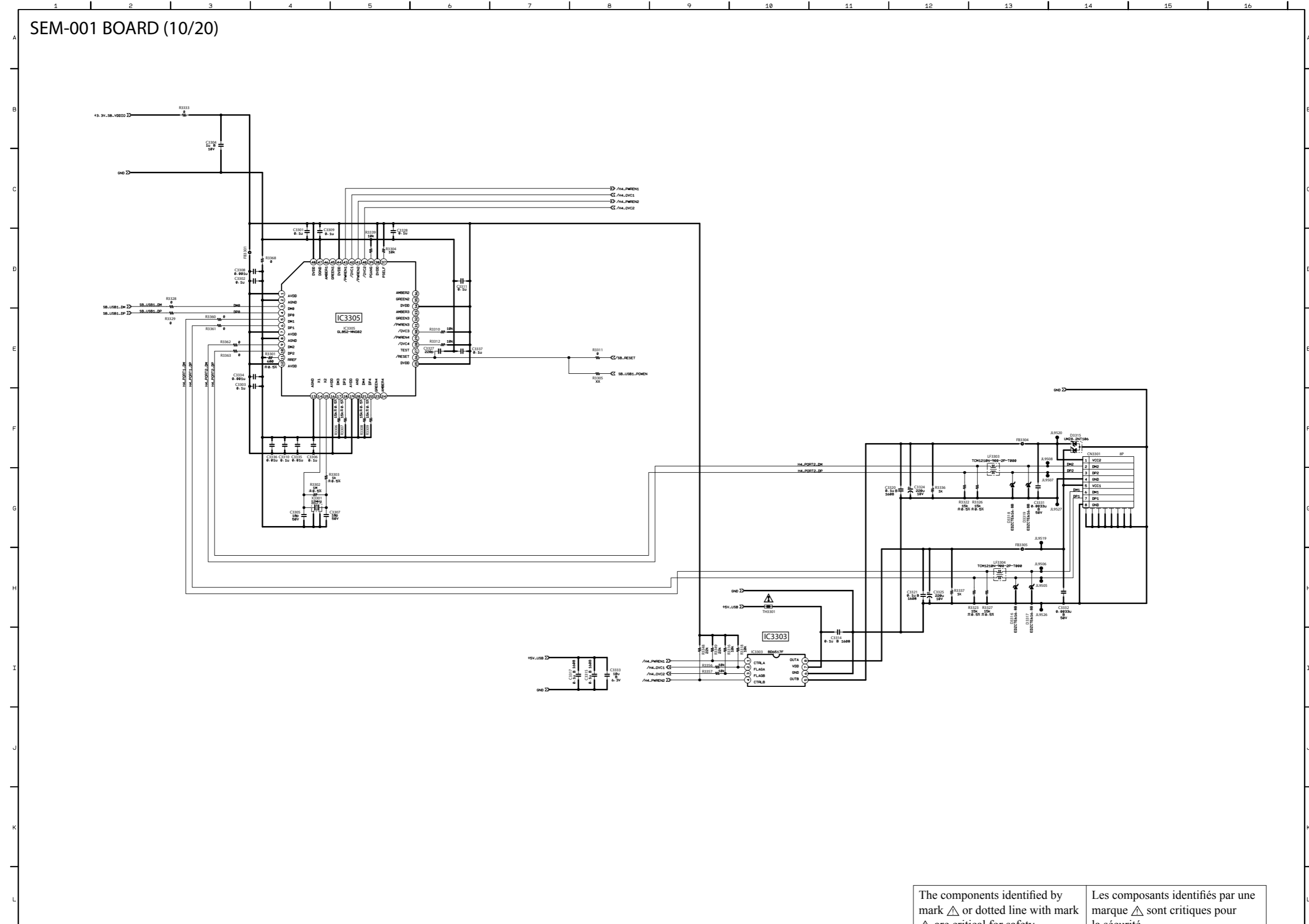

<p>The components identified by mark or dotted line with mark are critical for safety. Replace only with part number specified.</p>	<p>Les composants identifiés par une marque sont critiques pour la sécurité. Ne les remplacer que par une pièce portant le numéro spécifié.</p>
---	--

1-14. SEM-001 BOARD (11/20)

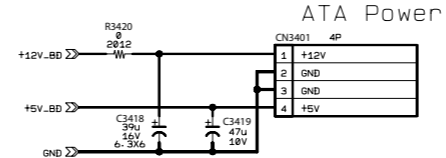
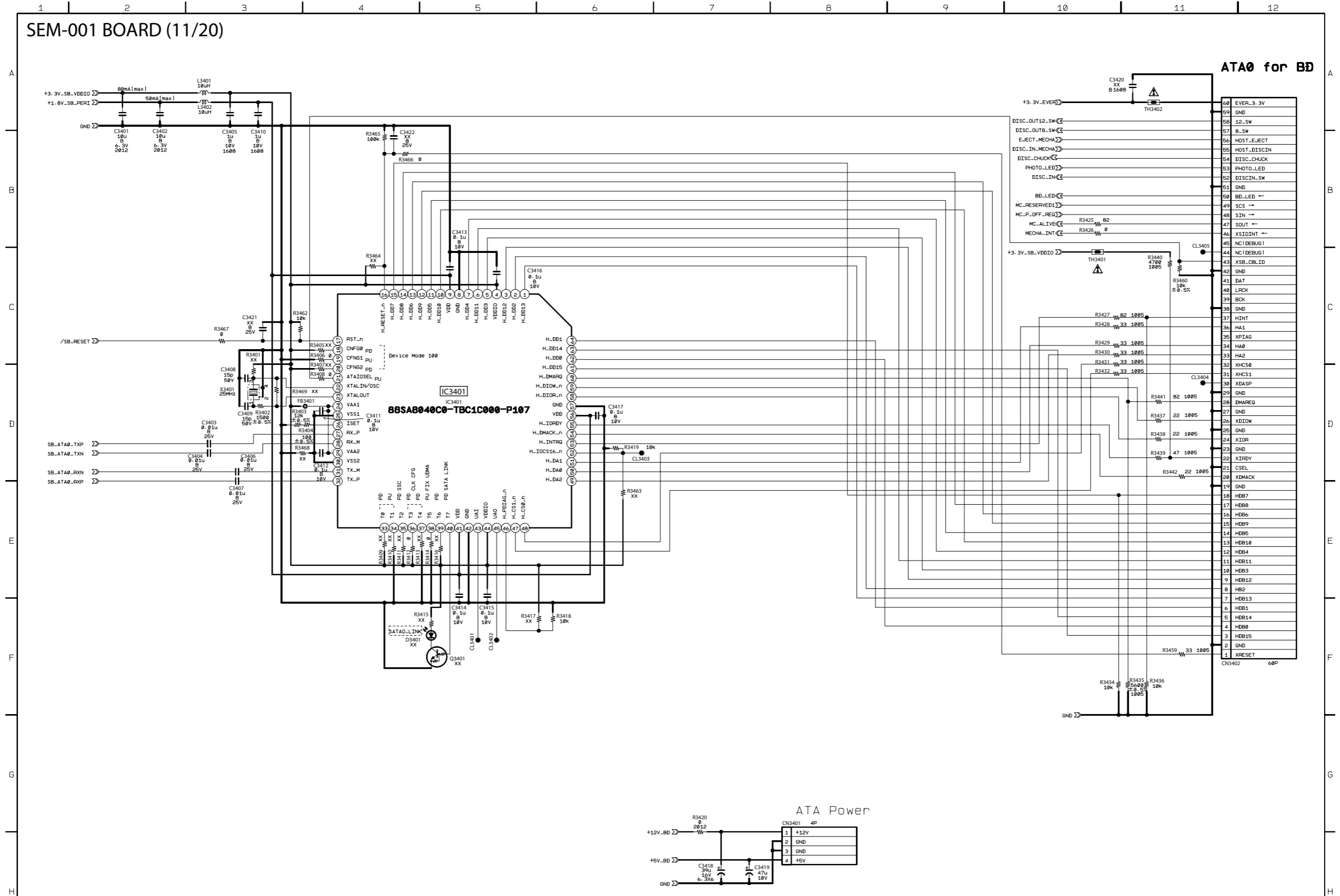

The components identified by mark \triangle or dotted line with mark \triangle are critical for safety. Replace only with part number specified.

Les composants identifiés par une marque \triangle sont critiques pour la sécurité. Ne les remplacer que par une pièce portant le numéro spécifié.

1-15. SEM-001 BOARD (12/20)

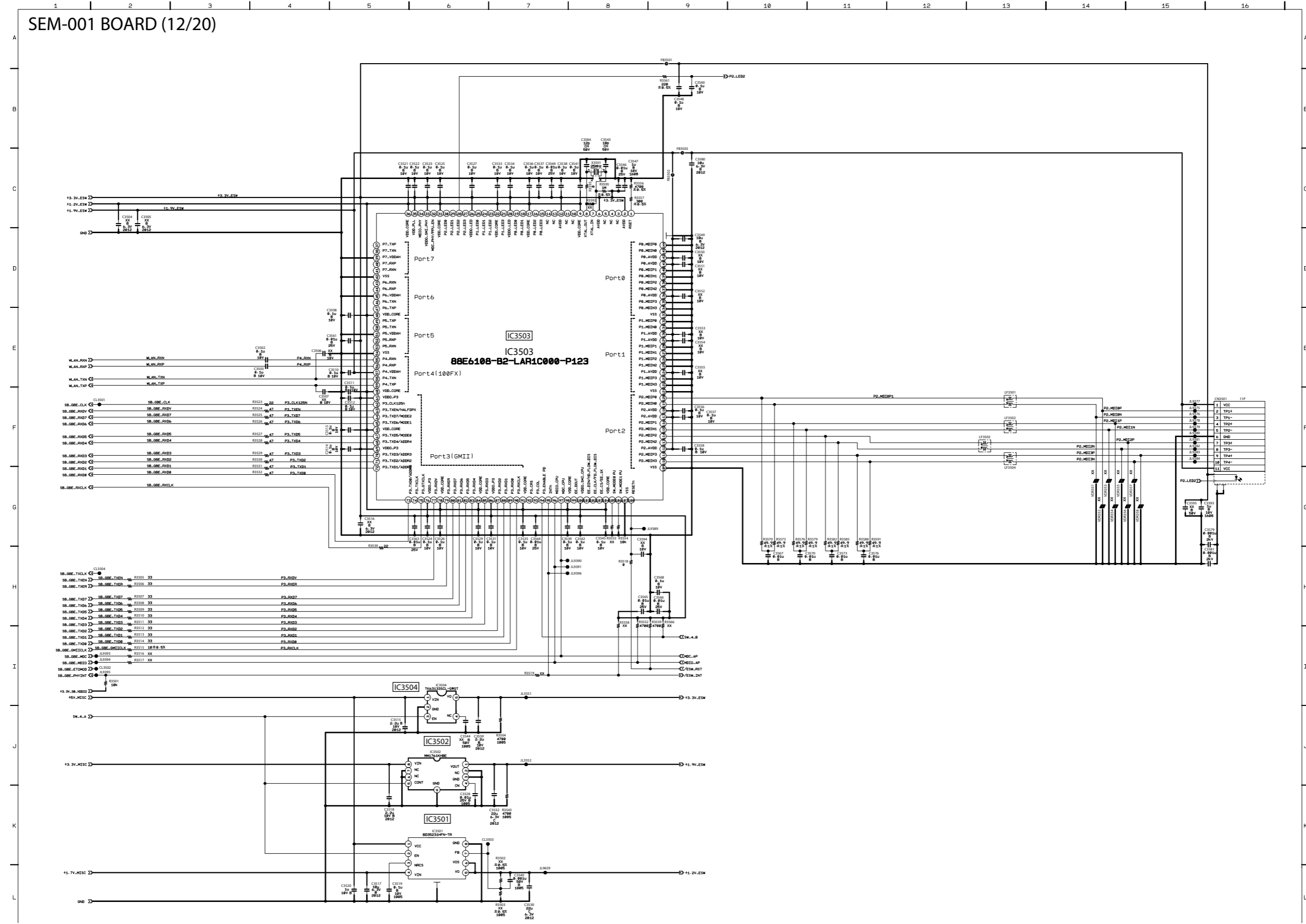

1-16. SEM-001 BOARD (13/20)

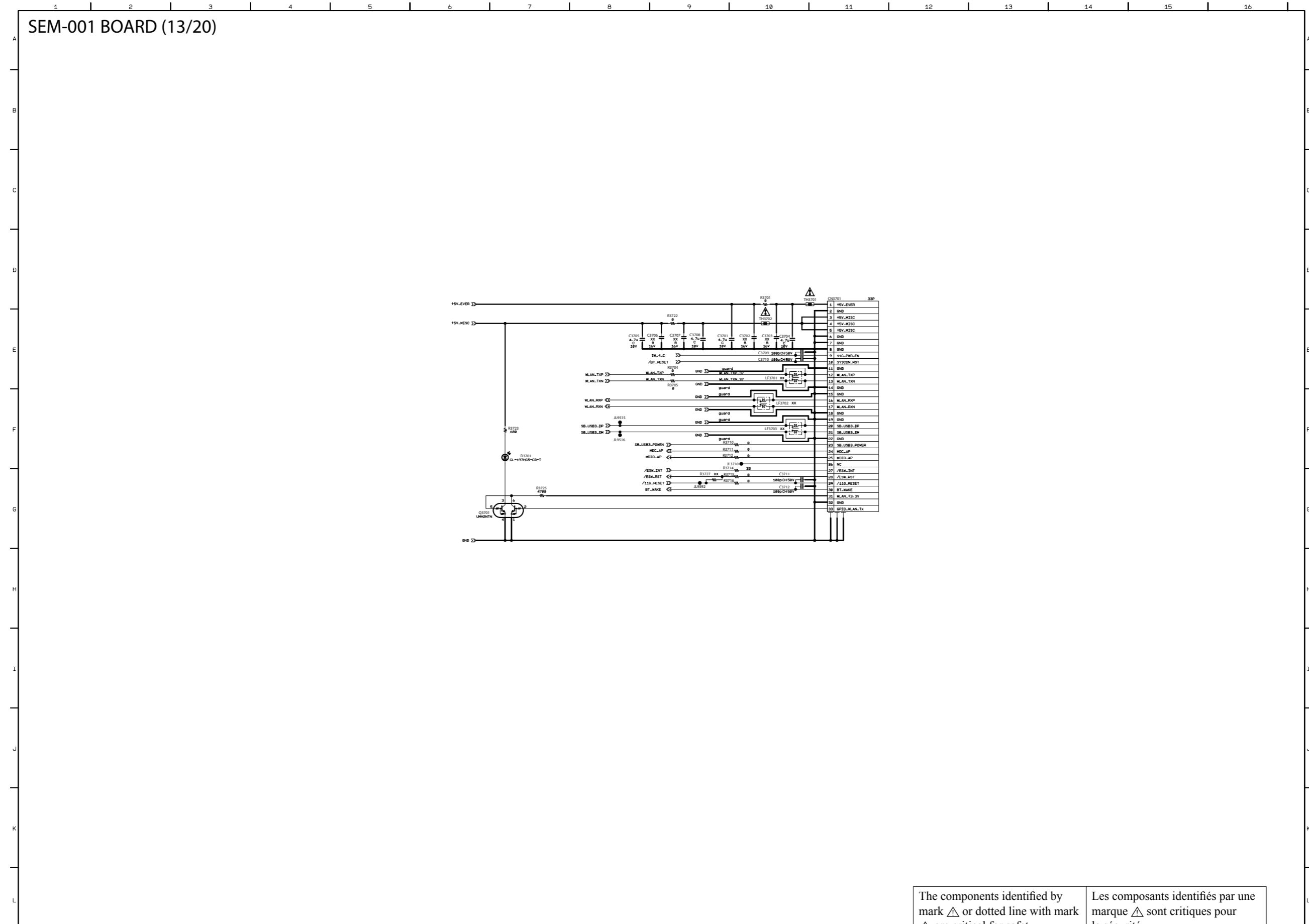

The components identified by mark \triangle or dotted line with mark \triangle are critical for safety. Replace only with part number specified.

Les composants identifiés par une marque \triangle sont critiques pour la sécurité. Ne les remplacer que par une pièce portant le numéro spécifié.

1-17. SEM-001 BOARD (14/20)

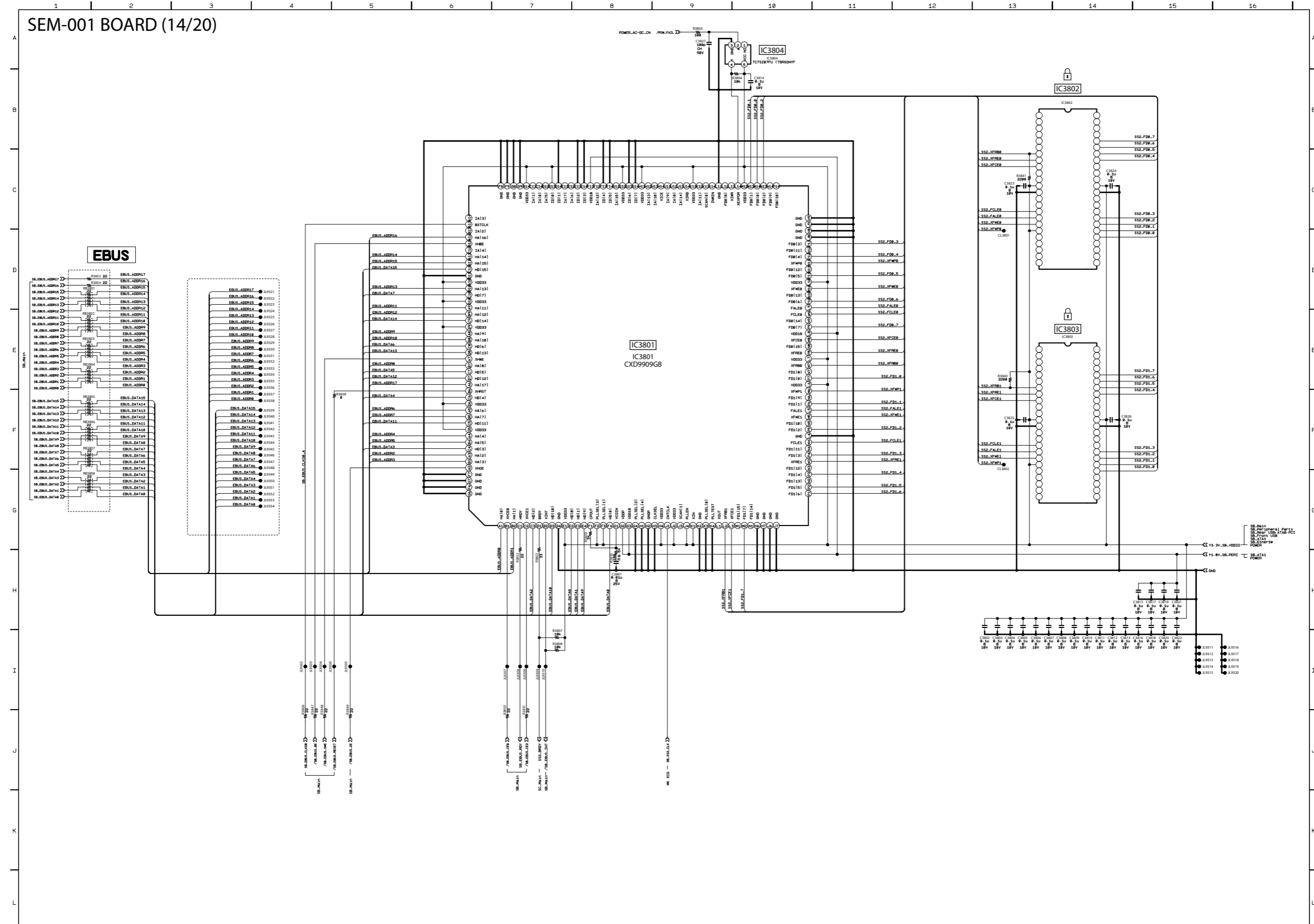

1-18. SEM-001 BOARD (15/20)

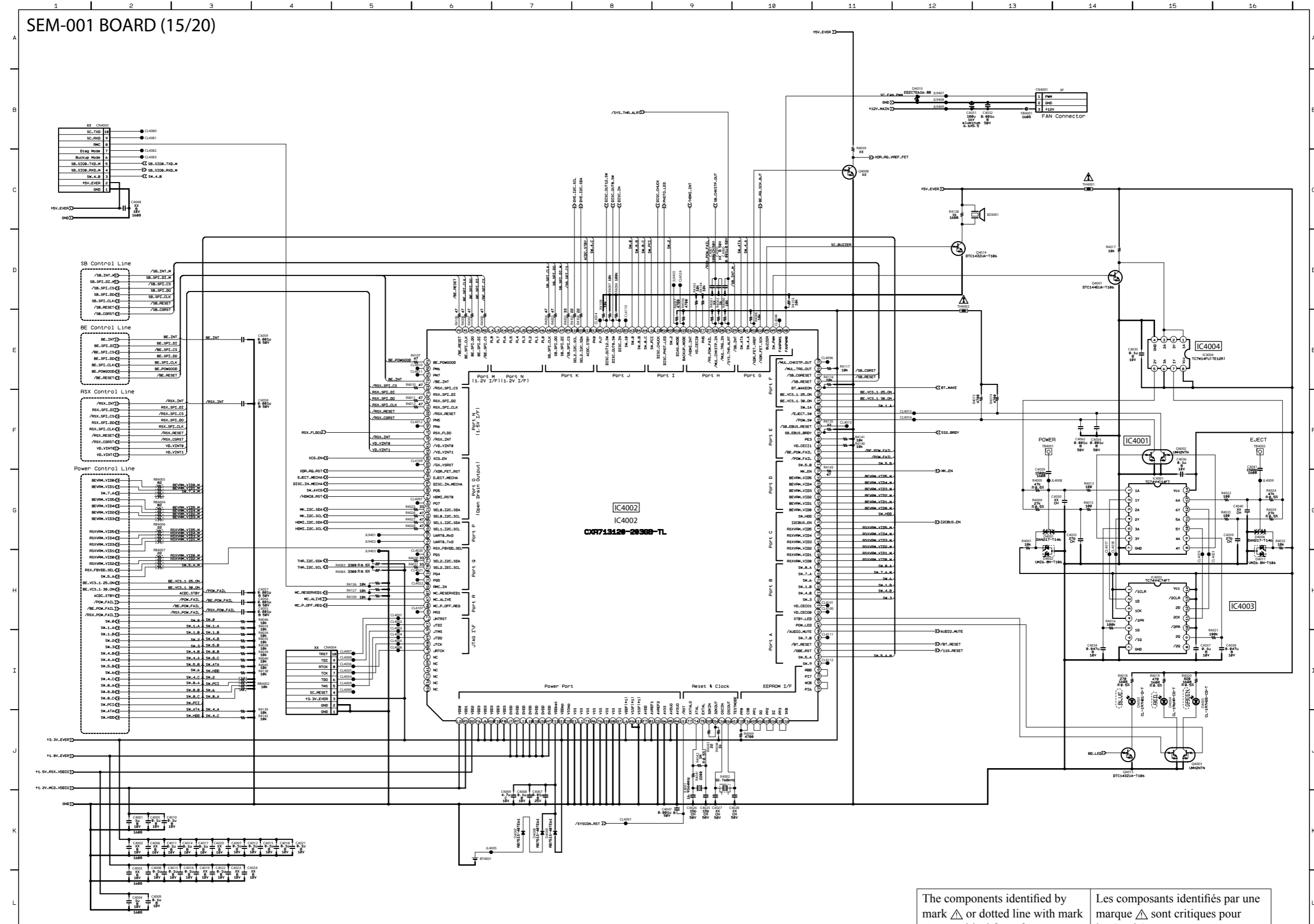

The components identified by mark \triangle or dotted line with mark \triangle are critical for safety. Replace only with part number specified.

Les composants identifiés par une marque \triangle sont critiques pour la sécurité. Ne les remplacer que par une pièce portant le numéro spécifié.

1-19. SEM-001 BOARD (16/20)

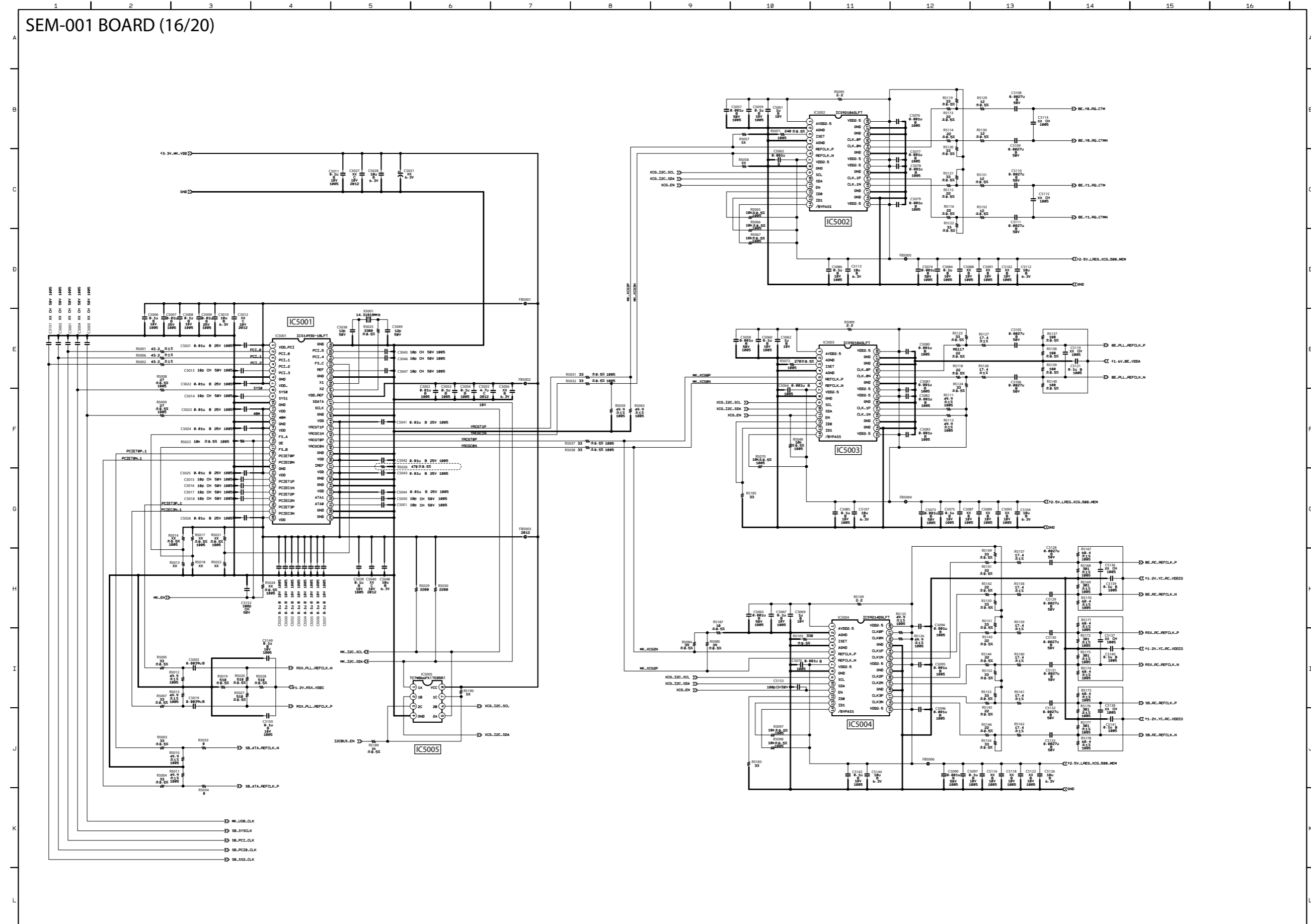

1-20. SEM-001 BOARD (17/20)

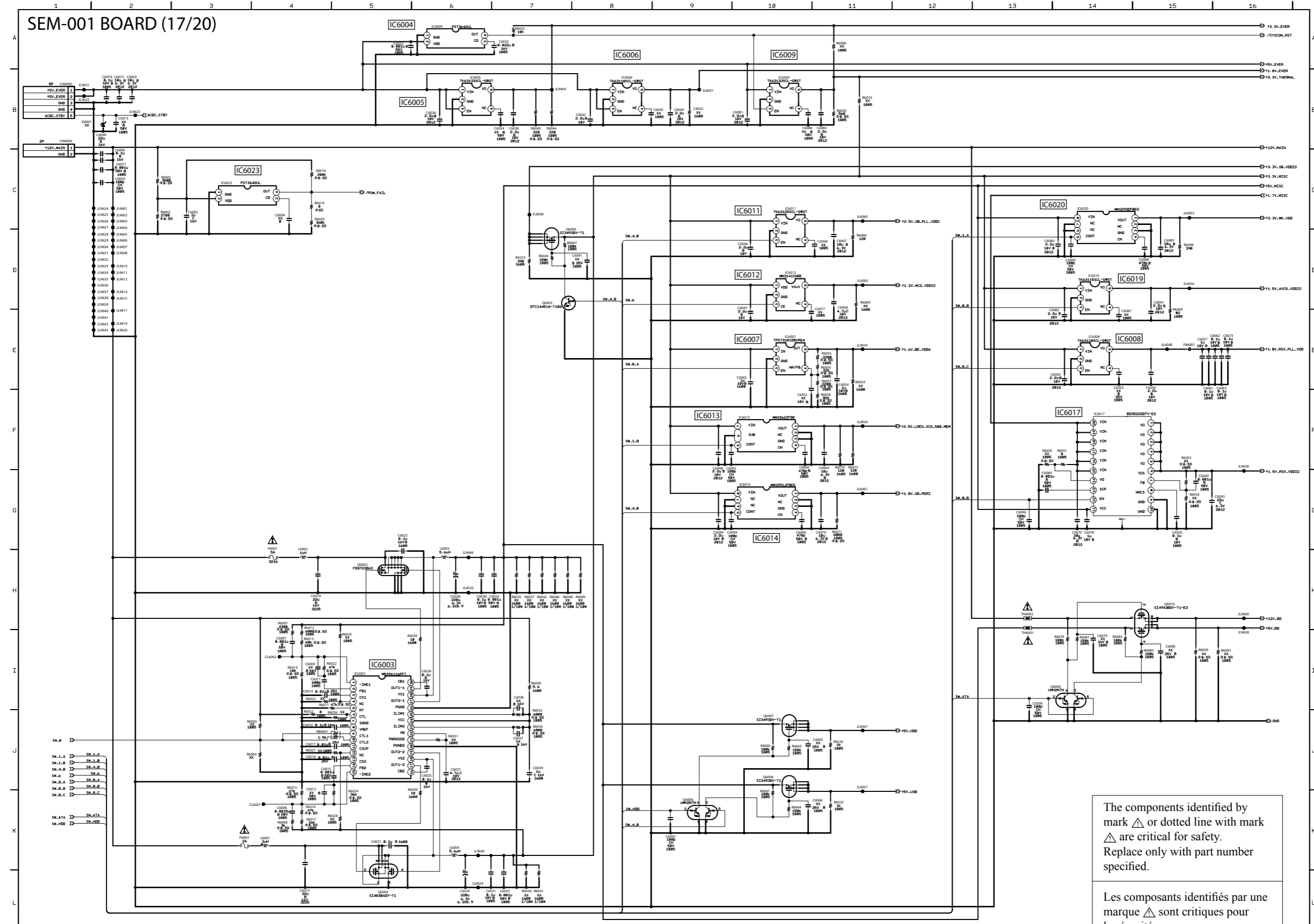

The components identified by mark △ or dotted line with mark △ are critical for safety. Replace only with part number specified.

Les composants identifiés par une marque △ sont critiques pour la sécurité. Ne les remplacer que par une pièce portant le numéro spécifié.

1-21. SEM-001 BOARD (18/20)

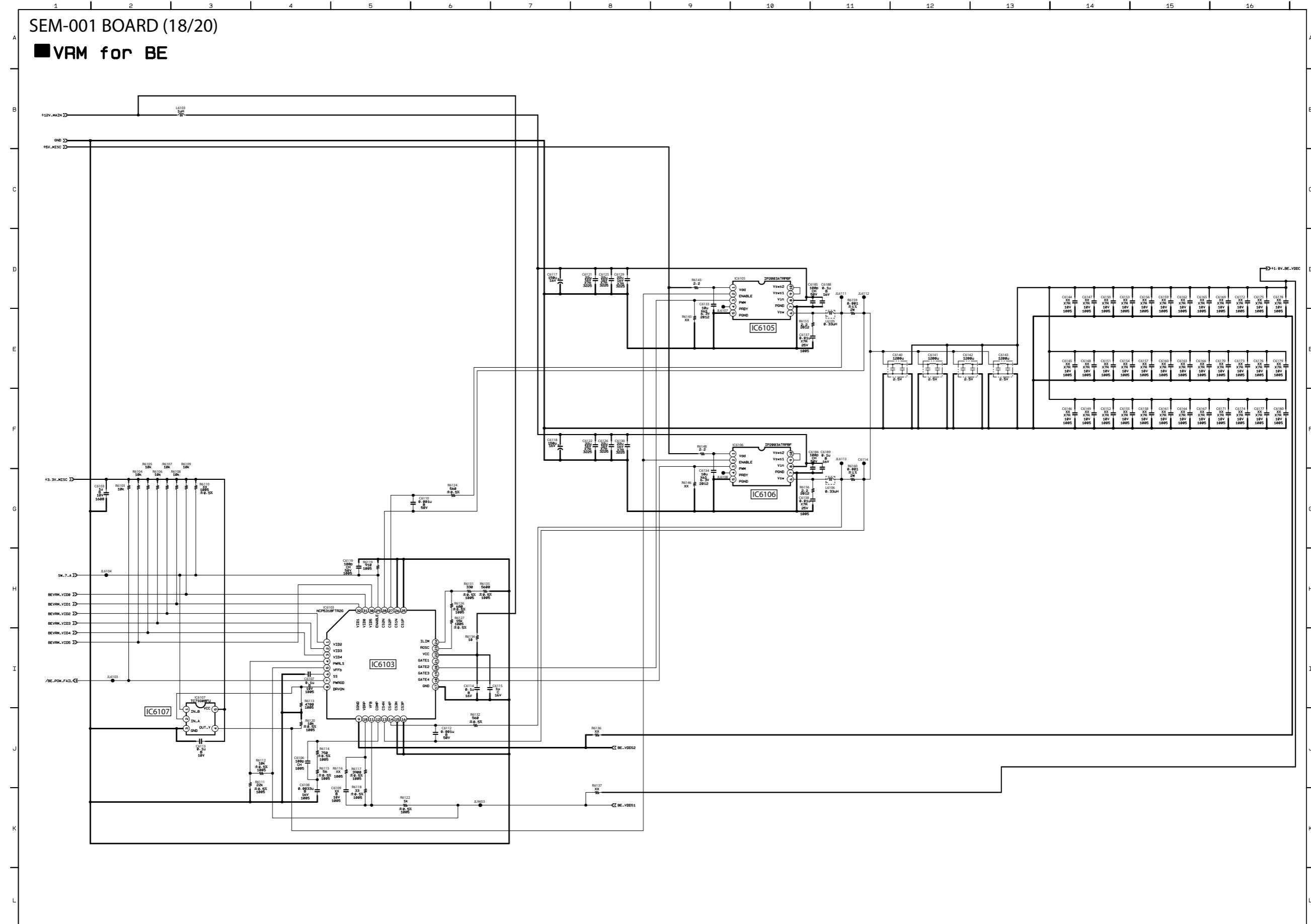

1-22. SEM-001 BOARD (19/20)

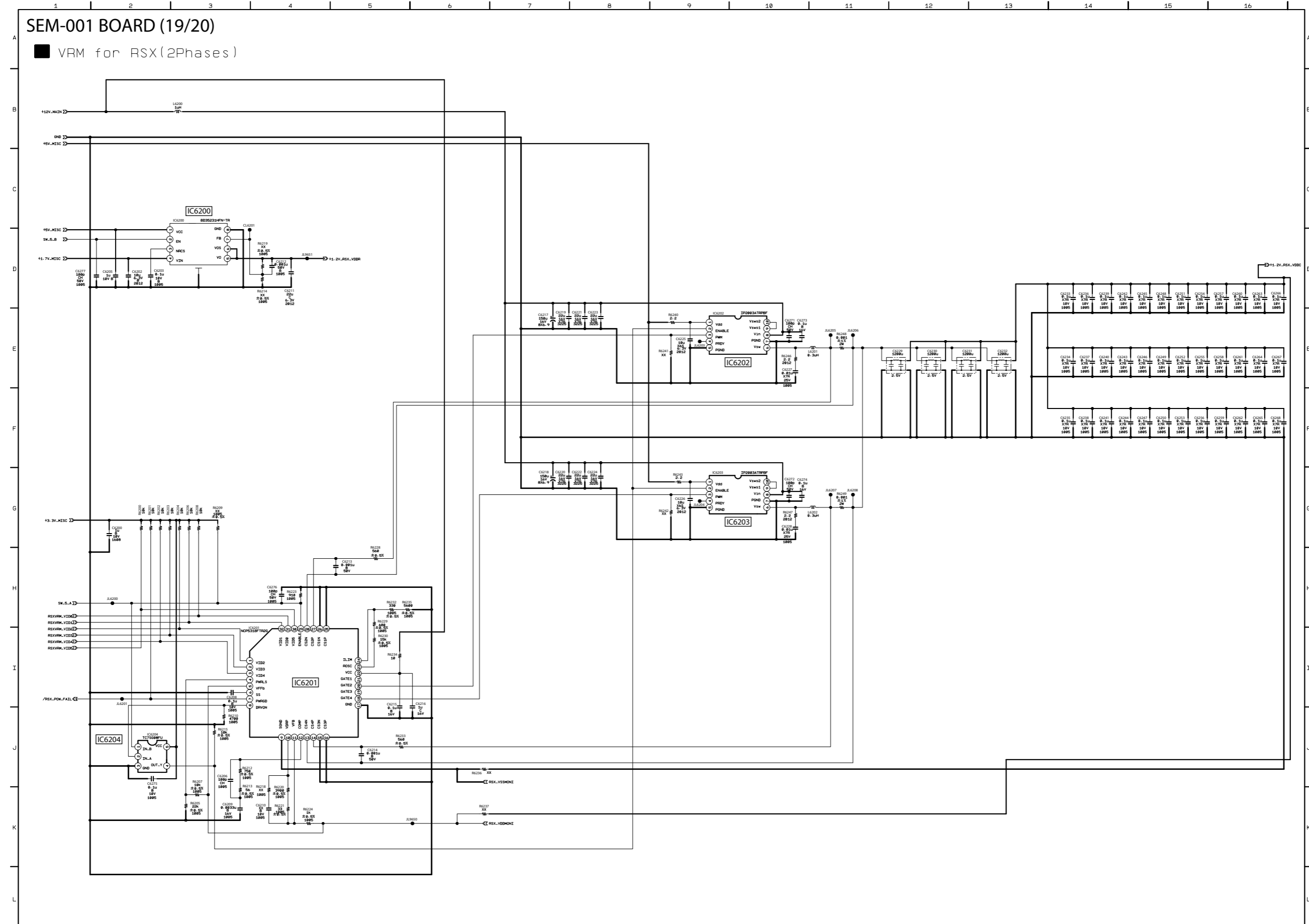

1-23. SEM-001 BOARD (20/20)

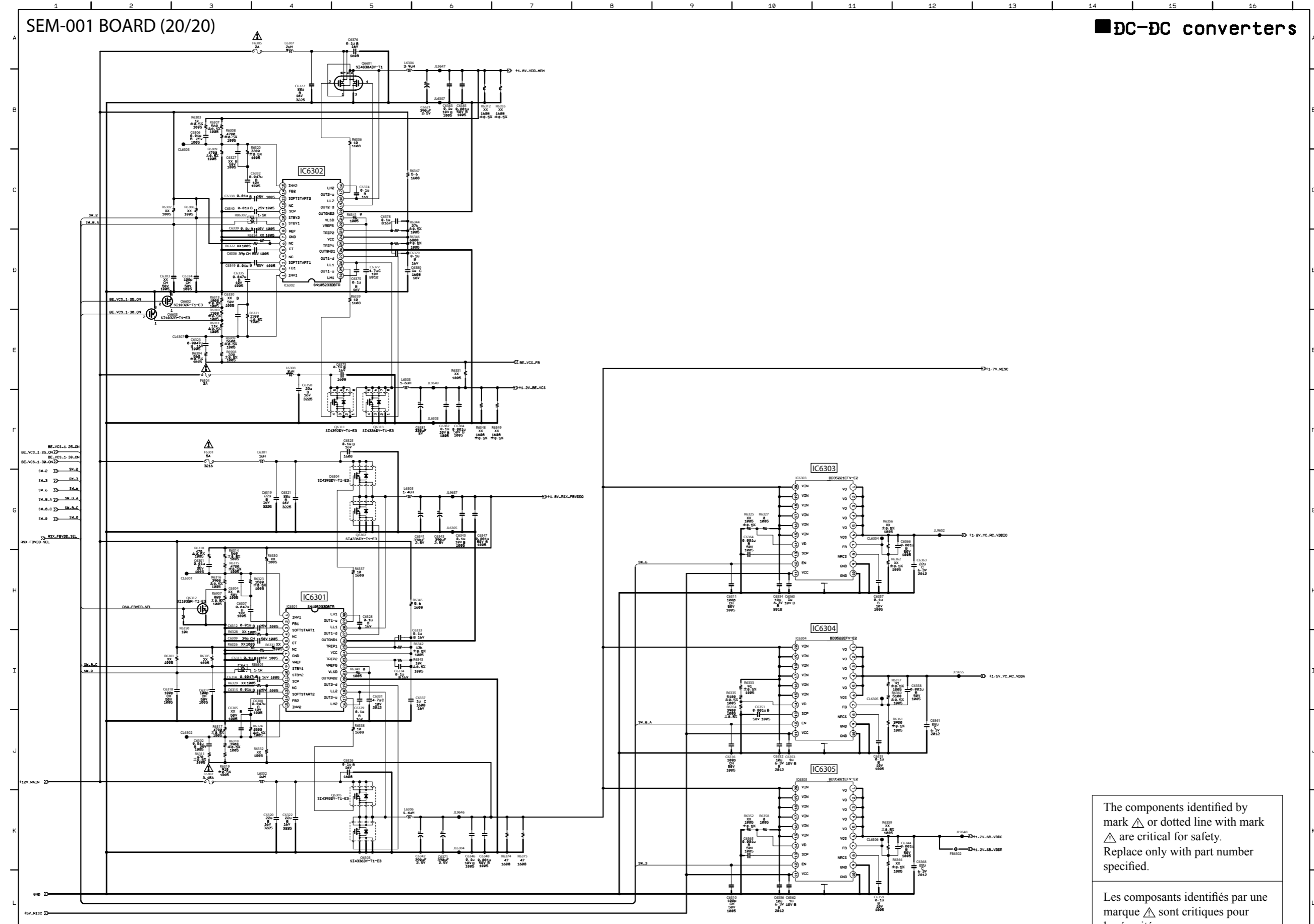

DC-DC converters

The components identified by mark △ or dotted line with mark △ are critical for safety. Replace only with part number specified.

Les composants identifiés par une marque △ sont critiques pour la sécurité. Ne les remplacer que par une pièce portant le numéro spécifié.

SECTION 2
PRINTED WIRING BOARDS

2-1. CWI-002 BOARD (SIDE A)

CWI-002 BOARD (SIDE A)

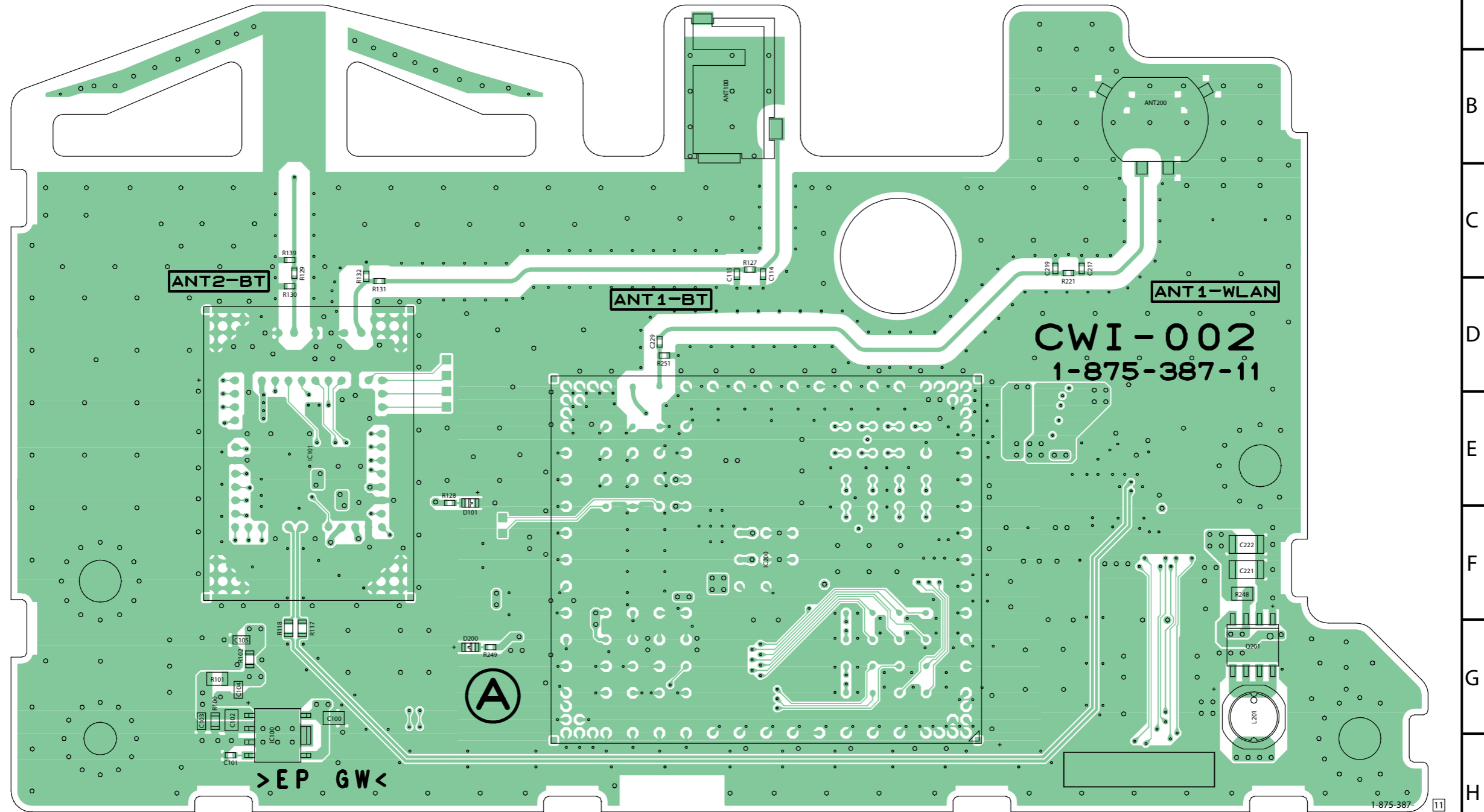

Note on Printed Wiring Boards:

- : Pattern from the side which enables seeing. (The other layer's patterns are not indicated.)

Caution:
 Pattern face side: Parts on the pattern face side seen (Side B) from the pattern face are indicated.
 Parts face side: Parts on the parts face side seen (Side A) from the parts face are indicated.

2-2. CWI-002 BOARD (SIDE B)

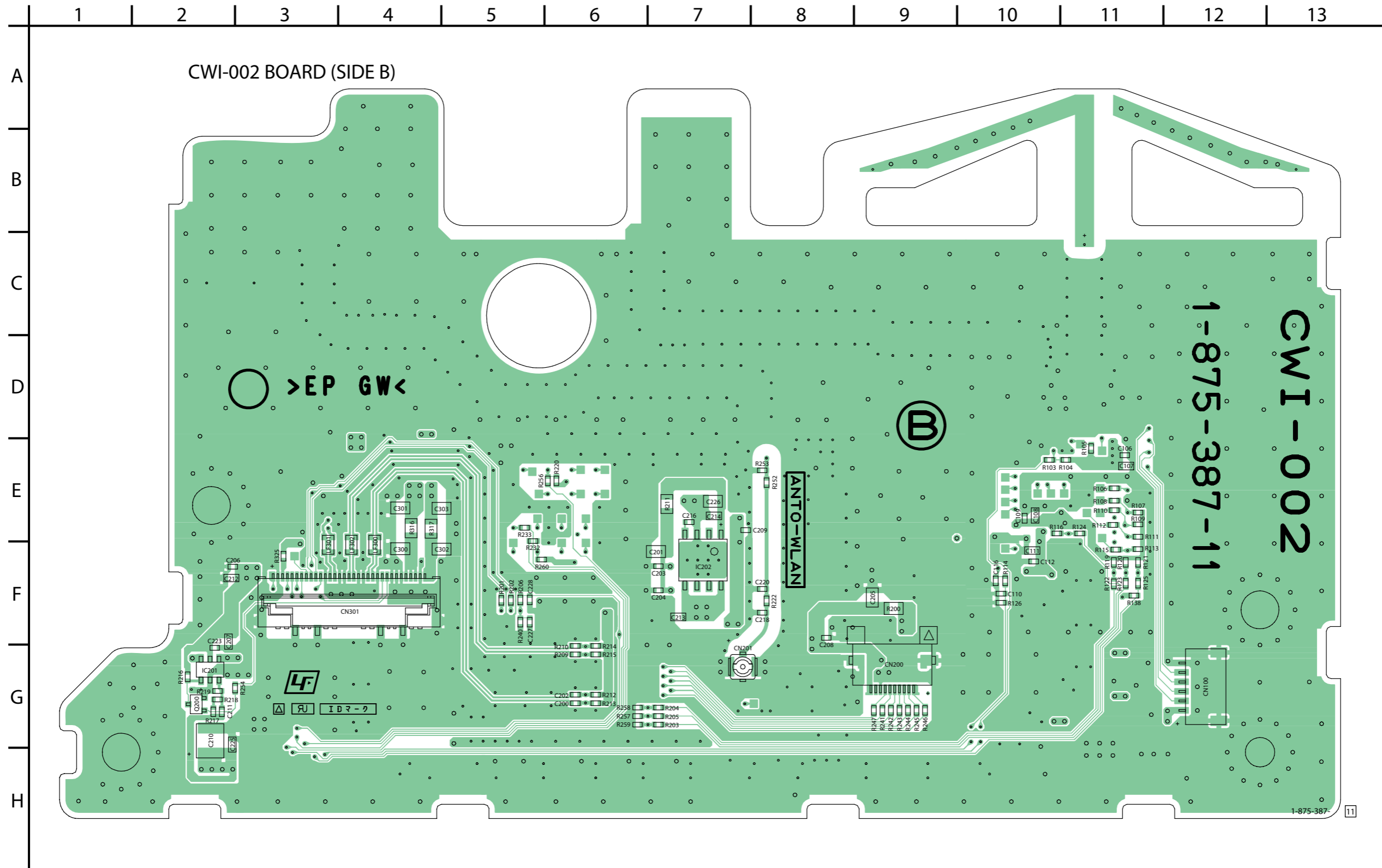

2-3. SEM-001 BOARD (SIDE A)

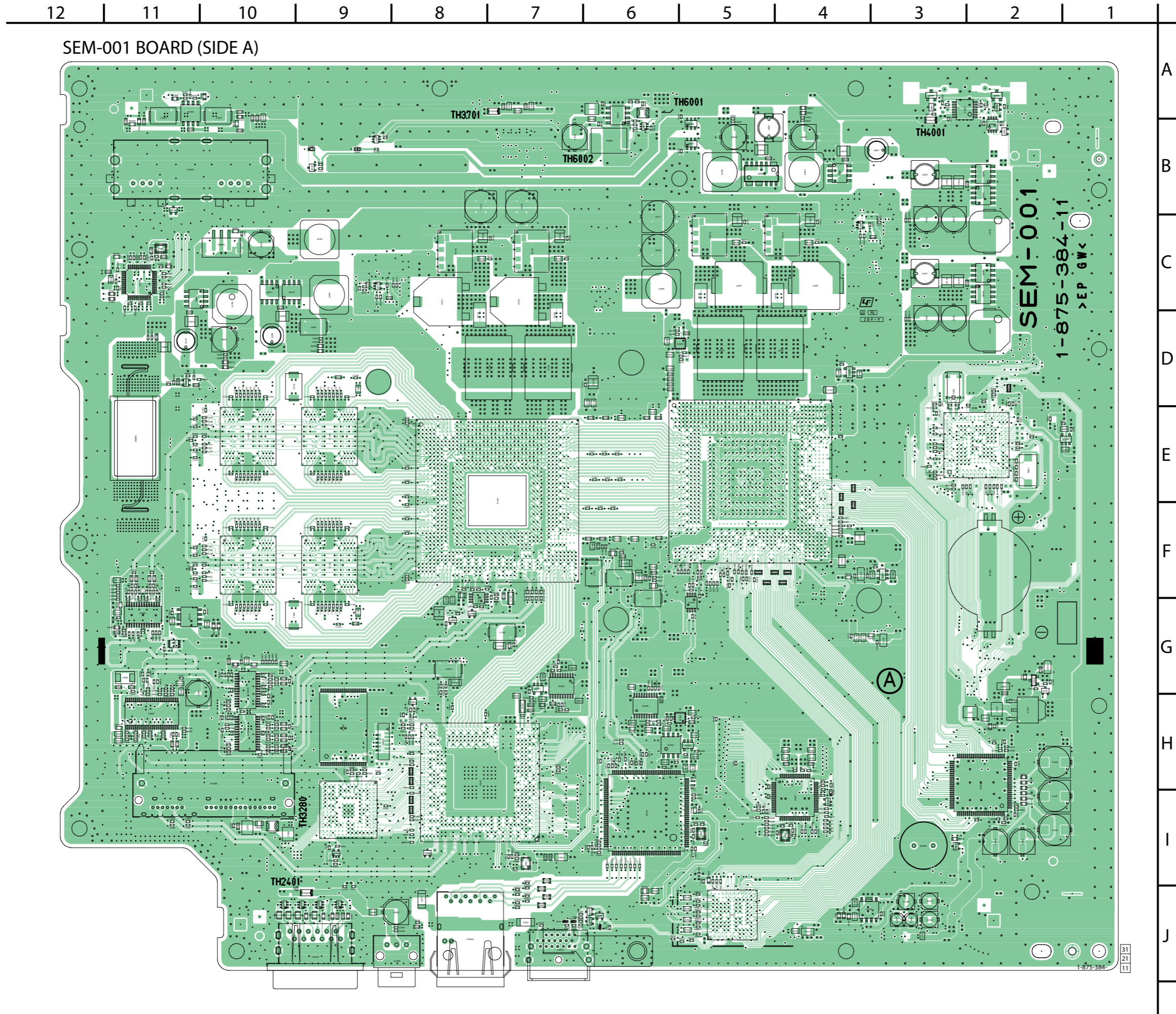

2-4. SEM-001 BOARD (SIDE B)

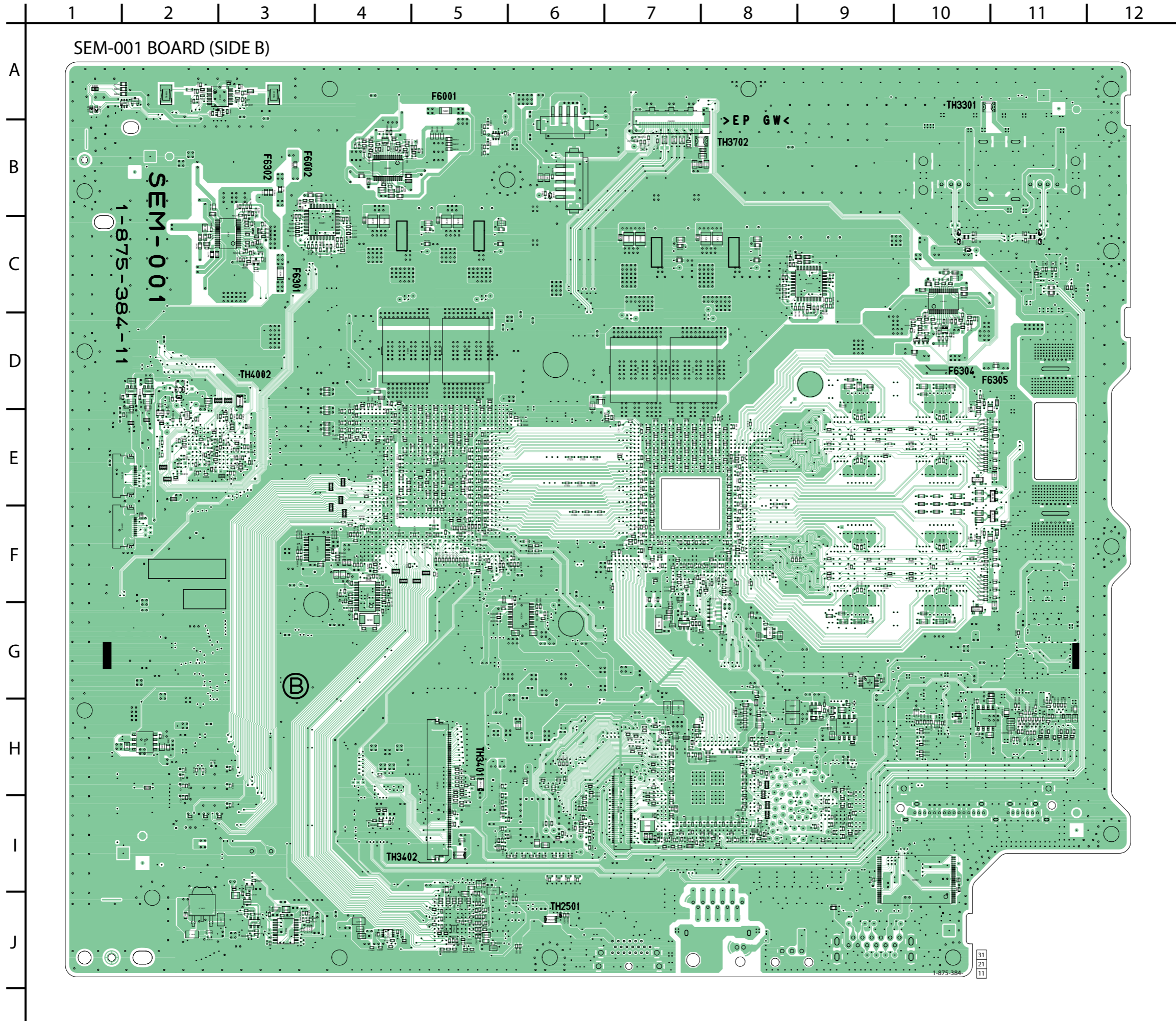

SC	Ref. No.	Part No.	Description	Remark	SC	Ref. No.	Part No.	Description	Remark	SC	Ref. No.	Part No.	Description	Remark	SC	Ref. No.	Part No.	Description	Remark
U	R5034		SHORT CHIP	0	U	R5157		METAL CHIP	17.4 1%	U	R6063		RES-CHIP	150K 5%	U	R6228		METAL CHIP	560 0.5%
U	R5037		METAL CHIP	33 0.5% 1/16W	U	R5158		METAL CHIP	17.4 1%	U	R6064		RES-CHIP	150K 5%	U	R6229		METAL CHIP	680 0.5%
U	R5038		METAL CHIP	33 0.5% 1/16W	U	R5159		METAL CHIP	17.4 1%	U	R6068		METAL CHIP	120 5%	U	R6230		METAL CHIP	15K 0.5%
U	R5039		METAL CHIP	49.9 1% 1/16W	U	R5160		METAL CHIP	17.4 1%	U	R6070		METAL CHIP	120 5%	U	R6232		METAL CHIP	330 0.5%
U	R5043		METAL CHIP	49.9 1% 1/16W	U	R5161		METAL CHIP	17.4 1%	U	R6071		METAL CHIP	6.8K 0.5%	U	R6233		METAL CHIP	560 0.5%
U	R5048		METAL CHIP	10K 0.5% 1/16W	U	R5162		METAL CHIP	17.4 1%	U	R6073		METAL CHIP	120 5%	U	R6234		METAL CHIP	10 5%
U	R5065		METAL CHIP	10K 0.5% 1/16W	U	R5167		METAL CHIP	60.4 1%	U	R6079		RES-CHIP	100K 5%	U	R6235		METAL CHIP	5.6K 0.5%
U	R5066		METAL CHIP	10K 0.5% 1/16W	U	R5168		METAL CHIP	301 1%	U	R6081		RES-CHIP	150K 5%	U	R6240		METAL CHIP	2.2 5%
U	R5067		METAL CHIP	10K 0.5% 1/16W	U	R5169		METAL CHIP	301 1%	U	R6083		RES-CHIP	100K 5%	U	R6243		METAL CHIP	2.2 5%
U	R5070		METAL CHIP	10K 0.5% 1/16W	U	R5170		METAL CHIP	60.4 1%	U	R6085		RES-CHIP	150K 5%	U	R6246		RES-CHIP	2.2 5%
U	R5071		METAL CHIP	240 0.5% 1/16W	U	R5171		METAL CHIP	60.4 1%	U	R6098		METAL CHIP	390 5%	U	R6247		RES-CHIP	2.2 5%
U	R5072		METAL CHIP	270 0.5% 1/16W	U	R5172		METAL CHIP	301 1%	U	R6103		RES-CHIP	10K 5%	U	R6248		METAL CHIP	0.001 1%
U	R5084		METAL CHIP	39 0.5% 1/16W	U	R5173		METAL CHIP	301 1%	U	R6104		RES-CHIP	10K 5%	U	R6249		METAL CHIP	0.001 1%
U	R5085		METAL CHIP	39 0.5% 1/16W	U	R5174		METAL CHIP	60.4 1%	U	R6105		RES-CHIP	10K 5%	U	R6303		METAL CHIP	1K 0.5%
U	R5095		METAL CHIP	2.2 5% 1/10W	U	R5175		METAL CHIP	60.4 1%	U	R6106		RES-CHIP	10K 5%	U	R6304		METAL CHIP	560 0.5%
U	R5097		METAL CHIP	10K 0.5% 1/16W	U	R5176		METAL CHIP	301 1%	U	R6107		RES-CHIP	10K 5%	U	R6307		METAL CHIP	560 0.5%
U	R5098		METAL CHIP	10K 0.5% 1/16W	U	R5177		METAL CHIP	301 1%	U	R6108		RES-CHIP	10K 5%	U	R6308		METAL CHIP	4.7K 0.5%
U	R5099		METAL CHIP	2.2 5% 1/10W	U	R5178		METAL CHIP	60.4 1%	U	R6109		RES-CHIP	10K 5%	U	R6309		METAL CHIP	4.7K 0.5%
U	R5103		METAL CHIP	330 0.5% 1/16W	U	R5183		RES-CHIP	33 5%	U	R6111		METAL CHIP	22K 0.5%	U	R6310		METAL CHIP	470 0.5%
U	R5109		METAL CHIP	2.2 5% 1/10W	U	R5185		RES-CHIP	33 5%	U	R6112		METAL CHIP	10K 0.5%	U	R6311		METAL CHIP	470 0.5%
U	R5111		METAL CHIP	49.9 1% 1/16W	U	R5187		METAL CHIP	10 0.5%	U	R6113		RES-CHIP	4.7K 5%	U	R6313		METAL CHIP	1.8K 0.5%
U	R5112		METAL CHIP	49.9 1% 1/16W	U	R5189		METAL CHIP	1K 0.5%	U	R6114		METAL CHIP	750 0.5%	U	R6314		METAL CHIP	560 0.5%
U	R5113		METAL CHIP	22 0.5% 1/16W	U	R6001		METAL CHIP	3.6K 0.5%	U	R6115		METAL CHIP	56 0.5%	U	R6315		METAL CHIP	4.7K 0.5%
U	R5114		METAL CHIP	22 0.5% 1/16W	U	R6002		METAL CHIP	2.7K 0.5%	U	R6117		METAL CHIP	3.9K 0.5%	U	R6316		METAL CHIP	3.9K 0.5%
U	R5115		METAL CHIP	22 0.5% 1/16W	U	R6005		METAL CHIP	560 0.5%	U	R6118		METAL CHIP	33 0.5%	U	R6317		METAL CHIP	4.7K 0.5%
U	R5116		METAL CHIP	22 0.5% 1/16W	U	R6007		METAL CHIP	4.3K 0.5%	U	R6119		RES-CHIP	910 5%	U	R6318		METAL CHIP	3.9K 0.5%
U	R5117		METAL CHIP	22 0.5% 1/16W	U	R6008		METAL CHIP	3K 0.5%	U	R6120		METAL CHIP	10K 0.5%	U	R6319		METAL CHIP	910 0.5%
U	R5118		METAL CHIP	22 0.5% 1/16W	U	R6009		RES-CHIP	82 5%	U	R6122		METAL CHIP	1K 0.5%	U	R6320		METAL CHIP	3.3K 0.5%
U	R5119		METAL CHIP	33 0.5% 1/16W	U	R6011		METAL CHIP	47K 0.5%	U	R6124		METAL CHIP	560 0.5%	U	R6321		METAL CHIP	1.3K 0.5%
U	R5120		METAL CHIP	33 0.5% 1/16W	U	R6012		METAL CHIP	6.8K 0.5%	U	R6126		METAL CHIP	680 0.5%	U	R6323		METAL CHIP	1.5K 0.5%
U	R5121		METAL CHIP	33 0.5% 1/16W	U	R6013		METAL CHIP	68K 0.5%	U	R6127		METAL CHIP	15K 0.5%	U	R6324		METAL CHIP	1.5K 0.5%
U	R5122		METAL CHIP	33 0.5% 1/16W	U	R6014		METAL CHIP	18K 0.5%	U	R6131		METAL CHIP	330 0.5%	U	R6327		SHORT CHIP	0
U	R5123		METAL CHIP	33 0.5% 1/16W	U	R6015		METAL CHIP	27K 0.5%	U	R6132		METAL CHIP	560 0.5%	U	R6333		METAL CHIP	91 0.5%
U	R5124		METAL CHIP	33 0.5% 1/16W	U	R6016		METAL CHIP	47K 0.5%	U	R6134		METAL CHIP	10 5%	U	R6335		METAL CHIP	5.1K 0.5%
U	R5125		METAL CHIP	49.9 1% 1/16W	U	R6017		METAL CHIP	16K 0.5%	U	R6135		METAL CHIP	5.6K 0.5%	U	R6336		METAL CHIP	10 5%
U	R5126		METAL CHIP	49.9 1% 1/16W	U	R6018		METAL CHIP	200K 0.5%	U	R6143		METAL CHIP	2.2 5%	U	R6337		METAL CHIP	10 5%
U	R5127		METAL CHIP	17.4 1% 1/16W	U	R6019		SHORT CHIP	0	U	R6148		METAL CHIP	2.2 5%	U	R6338		METAL CHIP	10 5%
U	R5128		METAL CHIP	17.4 1% 1/16W	U	R6020		METAL CHIP	360K 0.5%	U	R6155		RES-CHIP	2.2 5%	U	R6339		METAL CHIP	10 5%
U	R5129		METAL CHIP	12 0.5% 1/16W	U	R6021		SHORT CHIP	0	U	R6156		RES-CHIP	2.2 5%	U	R6340		SHORT CHIP	0
U	R5130		METAL CHIP	12 0.5% 1/16W	U	R6022		METAL CHIP	47K 0.5%	U	R6159		METAL CHIP	0.001 1%	U	R6341		SHORT CHIP	0
U	R5131		METAL CHIP	12 0.5% 1/16W	U	R6024		METAL CHIP	36K 0.5%	U	R6160		METAL CHIP	0.001 1%	U	R6342		METAL CHIP	13K 0.5%
U	R5132		METAL CHIP	12 0.5% 1/16W	U	R6029		METAL CHIP	10 5%	U	R6200		RES-CHIP	10K 5%	U	R6343		METAL CHIP	10K 0.5%
U	R5137		METAL CHIP	100 0.5% 1/16W	U	R6030		METAL CHIP	10 5%	U	R6201		RES-CHIP	10K 5%	U	R6344		METAL CHIP	27K 0.5%
U	R5138		METAL CHIP	100 0.5% 1/16W	U	R6032		RES-CHIP	10K 5%	U	R6202		RES-CHIP	10K 5%	U	R6345		METAL CHIP	5.6 5%
U	R5139		METAL CHIP	100 0.5% 1/16W	U	R6033		METAL CHIP	6.8K 0.5%	U	R6203		RES-CHIP	10K 5%	U	R6346		METAL CHIP	6.8K 0.5%
U	R5140		METAL CHIP	100 0.5% 1/16W	U	R6034		METAL CHIP	6.8K 0.5%	U	R6204		RES-CHIP	10K 5%	U	R6347		METAL CHIP	5.6 5%
U	R5141		METAL CHIP	22 0.5% 1/16W	U	R6038		METAL CHIP	5.6 5%	U	R6205		METAL CHIP	22K 0.5%	U	R6350		RES-CHIP	10K 5%
U	R5142		METAL CHIP	22 0.5% 1/16W	U	R6040		METAL CHIP	220 0.5%	U	R6206		RES-CHIP	10K 5%	U	R6354		METAL CHIP	3.9K 0.5%
U	R5143		METAL CHIP	22 0.5% 1/16W	U	R6044		METAL CHIP	220 0.5%	U	R6207		METAL CHIP	10K 0.5%	U	R6357		METAL CHIP	91 0.5%
U	R5144		METAL CHIP	22 0.5% 1/16W	U	R6045		RES-CHIP	150K 5%	U	R6208		RES-CHIP	10K 5%	U	R6358		SHORT CHIP	0
U	R5145		METAL CHIP	22 0.5% 1/16W	U	R6047		RES-CHIP	100K 5%	U	R6210		RES-CHIP	4.7K 5%	U	R6360		METAL CHIP	5.1K 0.5%
U	R5146		METAL CHIP	22 0.5% 1/16W	U	R6051		SHORT CHIP	0	U	R6212		METAL CHIP	750 0.5%	U	R6361		METAL CHIP	3.9K 0.5%
U	R5149		METAL CHIP	33 0.5% 1/16W	U	R6055		METAL CHIP	2.2K 0.5%	U	R6213		METAL CHIP	56 0.5%	U	R6374		METAL CHIP	47 5%
U	R5150		METAL CHIP	33 0.5% 1/16W	U	R6056		METAL CHIP	22K 0.5%	U	R6215		METAL CHIP	10K 0.5%	U	R6375		METAL CHIP	47 5%
U	R5151		METAL CHIP	33 0.5% 1/16W	U	R6057		METAL CHIP	2.2K 0.5%	U	R6220		METAL CHIP	3.9K 0.5%	U	R6523		METAL CHIP	390 5%
U	R5152		METAL CHIP	33 0.5% 1/16W	U	R6058		METAL CHIP	82K 0.5%	U	R6221		METAL CHIP	33 0.5%	U	R6524		RES-CHIP	1K 5%
U	R5153		METAL CHIP	33 0.5% 1/16W	U	R6060		RES-CHIP	100K 5%	U	R6223		RES-CHIP	910 5%	U	R6525		RES-CHIP	1K 5%
U	R5154		METAL CHIP	33 0.5% 1/16W	U	R6061		RES-CHIP	100K 5%	U	R6224		METAL CHIP	1K 0.5%	U	R6907		METAL CHIP	820 0.5%

SC	Ref. No.	Part No.	Description	Remark	SC	Ref. No.	Part No.	Description	Remark
U	R6908		METAL CHIP 220	0.5% 1/16W				< VIBRATOR >	
U	R6909		METAL CHIP 5.6K	0.5% 1/16W					
U	R6910		METAL CHIP 1.3K	0.5% 1/16W	S	X2101	1-813-876-11	VIBRATOR, CRYSTAL (24.576MHz)	
U	R6911		METAL CHIP 11K	0.5% 1/16W	S	X3301	1-813-877-11	VIBRATOR, CRYSTAL (12MHz)	
			< NETWORK RESISTOR >		S	X3401	1-813-052-21	VIBRATOR, CRYSTAL (25MHz)	
					S	X3501	1-813-052-21	VIBRATOR, CRYSTAL (25MHz)	
U	RB2401		RES, NETWORK 22X4 (1005)		S	X4001	1-781-768-21	VIBRATOR, CRYSTAL (16.9344MHz)	
U	RB2402		RES, NETWORK 22X4 (1005)		S	X4002	1-781-786-21	VIBRATOR, CRYSTAL (32.768kHz)	
U	RB2403		RES, NETWORK 22X4 (1005)		S	X5001	1-813-875-11	VIBRATOR, CRYSTAL (14.31818MHz)	
U	RB2404		RES, NETWORK 22X4 (1005)						
U	RB2405		RES, NETWORK 22X4 (1005)						
U	RB2406		RES, NETWORK 22X4 (1005)						
U	RB2407		RES, NETWORK 22X4 (1005)						
U	RB2408		RES, NETWORK 22X4 (1005)						
U	RB2409		RES, NETWORK 22X4 (1005)						
U	RB2501		RES, NETWORK 22X4 (1005)						
U	RB2502		RES, NETWORK 22X4 (1005)						
U	RB2503		RES, NETWORK 22X4 (1005)						
U	RB2504		RES, NETWORK 22X4 (1005)						
U	RB2505		RES, NETWORK 22X4 (1005)						
U	RB2506		RES, NETWORK 22X4 (1005)						
U	RB2507		RES, NETWORK 22X4 (1005)						
U	RB2508		RES, NETWORK 22X4 (1005)						
U	RB2509		RES, NETWORK 22X4 (1005)						
U	RB3801		RES, NETWORK 22X4 (1005)						
U	RB3802		RES, NETWORK 22X4 (1005)						
U	RB3803		RES, NETWORK 22X4 (1005)						
U	RB3804		RES, NETWORK 22X4 (1005)						
U	RB3805		RES, NETWORK 22X4 (1005)						
U	RB3806		RES, NETWORK 22X4 (1005)						
U	RB3807		RES, NETWORK 22X4 (1005)						
U	RB3808		RES, NETWORK 22X4 (1005)						
U	RB4002		RES, NETWORK 10KX4 (1005)						
U	RB4004		RES, NETWORK 82X4 (1005)						
U	RB4005		RES, NETWORK 82X4 (1005)						
U	RB4006		RES, NETWORK 22X4 (1005)						
U	RB4007		RES, NETWORK 22X4 (1005)						
U	RB6001		RES, NETWORK 1.5KX2 (1608)						
U	RB6301		RES, NETWORK 1.5KX2 (1608)						
U	RB6302		RES, NETWORK 1.5KX2 (1608)						
			< TERMINAL >						
U	TB4001		TERMINAL (ON BOARD CONTACT)						
U	TB4002		TERMINAL (ON BOARD CONTACT)						
			< THERMISTOR (POSITIVE) >						
S△	TH2401	1-805-726-11	THERMISTOR, POSITIVE						
S△	TH2501	1-805-726-11	THERMISTOR, POSITIVE						
S△	TH3280	1-802-243-11	THERMISTOR, POSITIVE						
S△	TH3301	1-802-243-11	THERMISTOR, POSITIVE						
S△	TH3401	1-805-762-11	THERMISTOR, POSITIVE						
S△	TH3402	1-805-762-11	THERMISTOR, POSITIVE						
S△	TH3701	1-805-762-11	THERMISTOR, POSITIVE						
S△	TH3702	1-802-243-11	THERMISTOR, POSITIVE						
S△	TH4001	1-805-762-11	THERMISTOR, POSITIVE						
S△	TH4002	1-805-762-11	THERMISTOR, POSITIVE						
S△	TH6001	1-802-243-11	THERMISTOR, POSITIVE						
S△	TH6002	1-802-246-11	THERMISTOR, POSITIVE						